



FLOWTITE Pipe Systems

Technical Characteristics



01	1 Production Process _____	3
02	2 Pipe Laminate _____	4
03	3 Product Benefits _____	4
	Features & Benefits	4
04	4 Applications _____	5
05	5 Performance Standards _____	6
	5.1 ASTM	6
	5.2 AWWA	6
	5.3 ISO and EN Standards	6
	5.4 Control Testing Raw Materials	6
	5.5 Finished Pipe	7
	5.6 Qualification Testing	7
06	6 Underground Pipe System Design _____	10
	6.1 Static Calculation Methods of Underground Pipe System	10
	6.1.1 Summary of AWWA Design Chapter AWWA M-45	10
	6.1.2 Summary of ATV-DVWK-A 127	12
	6.2 Buoyancy	14
	6.3 Hydro-Testing	14
	6.4 Surge and Water Hammer	14
	6.5 Load Capacity Values	15
	6.6 Flow Velocity	15
	6.7 UV Resistance	15
	6.8 Poisson's Ratio	15
	6.9 Temperature	15
	6.10 Thermal Coefficient	15
	6.11 Flow Coefficients	16
	6.12 Abrasion Resistance	16
	6.13 External Collapse Pressure	16
	6.14 Hydraulics	16
	6.15 Liquid Flow	16
07	7 Product Range _____	18
	7.1 Stiffness Classes	18
	7.2 Pressure	19
	7.3 Lengths	19
08	8 Pipe Joining _____	19
	Other Joining Systems	20
09	9 Pipe Classification Selection _____	22
10	10 General Installation _____	24
11	11 AMITTOOLS _____	31
12	12 Appendix A / Environmental Guide for Pipes _____	32

1 Production Process

FLOWTITE pipes are manufactured using the continuous advancing mandrel process which represents the state of the art in GRP pipe production. This process allows the use of continuous glass fibre reinforcements in the circumferential direction. For a pressure pipe or buried conduit the principle stress is in the circumferential direction, thus incorporating continuous reinforcements in this direction yields a higher performing product at lower cost. Using technology developed by material specialists, a very compressed laminate is created that maximizes the contribution from the three basic raw materials. Both continuous glass fibre rovings and choppable roving are incorporated for high hoop strength and axial reinforcement. A sand fortifier is used to provide increased stiffness by adding extra thickness, placed near the neutral axis in the core. With the FLOWTITE dual resin delivery system, the equipment has the capability of applying a special inner resin liner for severely corrosive applications while utilising a standard type resin for the structural and outer portion of the laminate.

Taking advantage of the winding process, other materials such as a glass veil or a polyester veil can be used to enhance the abrasion, the chemical resistance and the finishing of the pipe. To assure a consistently high level of product quality, it is essential that the method of fabrication be accurately controlled.

The FLOWTITE filament winding machine represents the most advanced state-of-the-art technology in use, and is the foremost method of manufacturing glass fibre pipe. Simply put, this manufacturing machine consists of a continuous steel band mandrel supported by beams in a cylindrical shape.

As the beams turn, friction pulls the steel band around and a roller bearing allows the band to move longitudinally so that the entire mandrel moves continuously in a spiral path towards the exit assembly. As the mandrel rotates, all composite materials are metered onto it in precise amounts. Electronic sensors provide continuous production parameter feedback so that the various feeding systems apply the right amount of material. This ensures that the amount of material needed to build the different layers is applied throughout the manufacturing stage. Firstly, mould-release film, followed by various forms and patterns of glass fibres, embedded in a polyester resin matrix. The structural layers are made of glass and resin only, whereas the core layer includes pure silica. It is the continuous application of these materials onto the mandrel which forms the pipe.

After the pipe has been formed on the mandrel, it is cured and later cut to the required length. The ends of the pipe section are calibrated to fit the coupling.

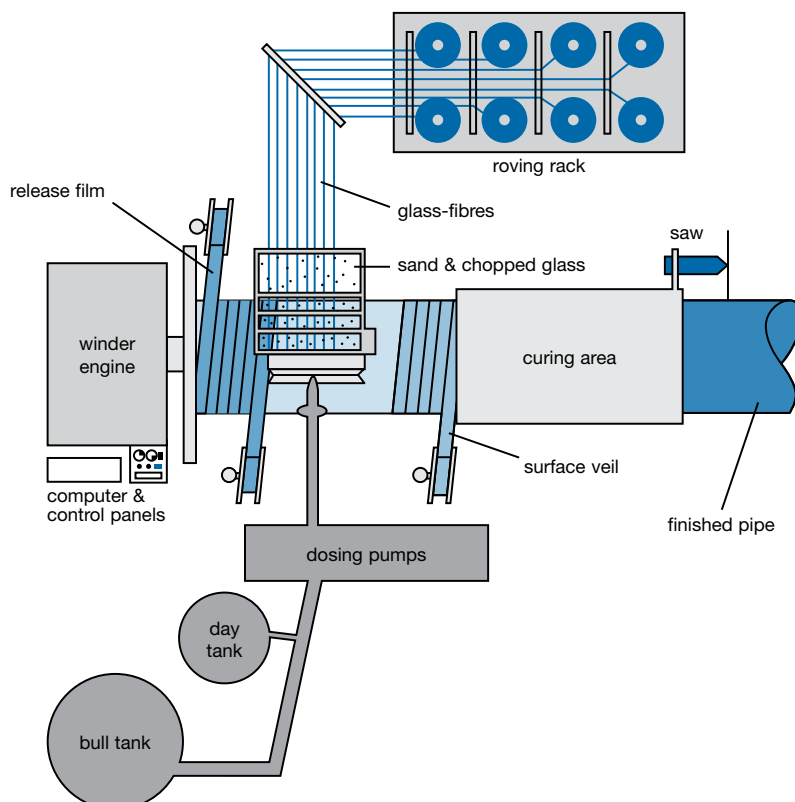

2 Pipe Laminate

The basic raw materials used in manufacturing the pipes are resin, fibreglass and silica sand. Under normal circumstances, orthophthalic polyester resins are used since they give good performance for most applications. Only FLOWTITE approved raw materials can be used for the production of the FLOWTITE pipe.

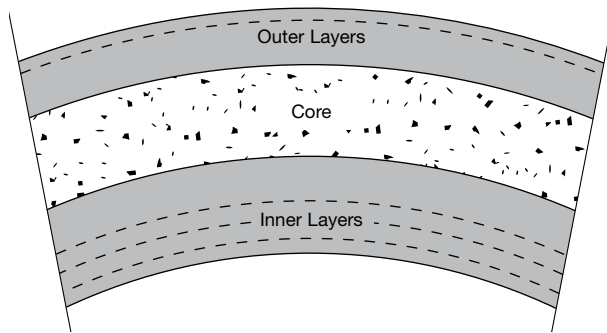

The figure above shows a typical cross section of a pipe laminate. This section, as well as the way of applying and placing the different raw materials, can differ depending on the pipe application.

The principle of continuous endless production allows pipes to be manufactured in diameters of DN 300 to DN 4000 mm. Diameters DN 100- DN 250 are available in standard lengths of 6m.



3 Product Benefits

FLOWTITE Technology has been able to bring a product to the market that can provide low cost, long term piping solutions to customers around the world. The long list of features and benefits add up to provide an optimum system of installation and life cycle cost

Features & Benefits

Corrosion Resistant

- Long, effective service life
- No need for linings, coatings, cathodic protection, wraps or other forms of additional corrosion protection
- Low maintenance costs
- Hydraulic characteristics essentially constant over time

Light Weight

(1/4 weight of DIP; 1/10 weight of concrete)

- Low transportation costs (nestable)
- Eliminates need for expensive pipe handling equipment

Long Standard Lengths

(6, 12 and 18 meters)

- Fewer joints reduces installation time
- More pipes per truckload means lower delivered cost

Superior Hydraulic Characteristics

- Extremely Smooth Bore
- Hazen Williams flow coefficient of approximately $C=150$
- Low friction means less pumping energy needed and lower operating costs
- Manning's flow coefficient $n = 0.009$
- Minimal slime build-up means lower cleaning costs
- Excellent abrasion resistance

Precision FLOWTITE Coupling with Elastomeric Gaskets

- Tight, efficient joints designed to eliminate infiltration or exfiltration
- Ease of joining, reduces installation time
- Accommodates small changes in line direction or differential settlements without additional fittings

Flexible Manufacturing Process

- Custom diameters can be manufactured to provide maximum flow volumes with ease of installation for sliplining projects
- Custom lengths can be manufactured to provide maximum flexibility for ease of direct bury or sliplining installation

4 Applications

01

02

03

04

05

06

07

08

09

10

11

12

Advanced Technology Pipe Design

- Multiple pressure and stiffness classes to meet the design engineer's criteria
- Lower wave celerity than other piping materials can mean less cost when designing for surge and water hammer pressures
- High and consistent product quality worldwide which complies with stringent product performance standards (ASTM, AWWA, DIN-EN...)

GRP pipes from FLOWTITE can be used in numerous applications including:

- Water transmission and distribution (potable and raw water)
- Sanitary sewerage collection systems and outfalls
- Storm water
- Hydroelectric penstock lines
- Sea water intake and outfalls
- Circulating cooling water, make-up and blow down lines for power plants
- Industrial applications
- Slip-lining
- Irrigation/Agricultural
- Desalination
- Mining
- Cooling systems



5 Performance Standards

FLOWTITE Fibreglass pipe systems are certified according to many national and international standards. Standards developed by ASTM, AWWA and the last ISO and EN are applied to a variety of fibreglass pipe applications, including conveyance of sanitary sewage, water and industrial waste. A thread common to all of the product standards is that they are all performance based documents. This means that the required performance and testing of the pipe is specified.

Inspection and testing of samples taken from sewer pipes that have been in service for almost 24 years were found to be in impeccable condition. This and the analysis of times-to-failure datapoints from a few hours up to 28 years and how they relate to the standardized method and regression analysis show safety margins to be higher than expected and extrapolation even up to 150 years could be achieved.

5.1 ASTM

Currently, there are several ASTM Product Standards in use, which apply to a variety of fibreglass pipe applications. All product standards apply to pipe with diameter ranges of 200 mm to 3600 mm and require the flexible joints to withstand hydrostatic testing in configurations (per ASTM D4161) that simulate exaggerated in-use conditions. These standards include many tough qualification and quality control tests.

ASTM standards are:

- ASTM D3262 Gravity Sewer
- ASTM D3517 Pressure Pipe
- ASTM D3754 Pressure Sewer

5.2 AWWA

AWWA C950 is one of the most comprehensive product standards in existence for fibreglass pipe. This standard for pressure water applications has extensive requirements for pipe and joints, concentrating on quality control and prototype qualification testing. Like ASTM standards, this is a product performance standard. AWWA issued a manual, M-45, which includes several chapters on the design of GRP pipe for buried and aboveground installations. The documents developed by AWWA are:

- AWWA C950 Fibreglass Pressure Pipe
- AWWA M-45 Fibreglass Pipe Design Manual

5.3 ISO and EN Standards

There are currently some standards used in the EU, such as the ones developed by BSI (BS 5480), DIN (DIN 16868) and AENOR (UNE 53323-EX). All these standards will be substituted by the work done in the light of the European organisation.

EN 1796 and EN 14364 are the documents for water and sewer applications that in the short term will replace the existing ones in Europe.

The International Standards Organization (ISO) has issued two standards; ISO 10467 for drainage and sewerage and ISO 10639 for water

AMIANITIT is participating in the development of all these standards with representatives from its worldwide organisation, thereby ensuring performance requirements that result in reliable products.

5.4 Control Testing Raw Materials

Raw materials are delivered with vendor certification demonstrating their compliance with FLOWTITE quality requirements. In addition, all raw materials are qualified and tested prior to their use. These tests ensure that the pipe materials comply with the specifications as stated. Raw materials should, according to FLOWTITE quality requirements, be pre-qualified in such a way that their suitability to be used in the process and in the final product is demonstrated by its long term performance.

Raw materials used in pipe production are:

- Glass
- Resin
- Catalyst
- Sand
- Accelerator

Only FLOWTITE approved raw materials can be used in the production of the FLOWTITE pipe.

Glass

Glass fibre is specified by tex which is = weight in grams/1000 meters length

Hoop roving

Continuous roving used in different tex for the production of the "FLOWTITE" pipe

Chop roving cut directly on the machine to provide strength in different directions.

Resin

Only qualified resins are used the for winding process. Usually they are delivered in drums or bulk.

The resin is prepared in day tanks at the winder. Normal application temperature is 25°C.

Resin is delivered from producer and may be diluted before use on the winder with styrene to reach the required and acceptable viscosity defined by “FLOWTITE Technology”.

Catalyst

The right amount of catalyst is mixed with the resin just before application on the mandrel. Only approved catalysts are used in the manufacturing process of the “FLOWTITE” pipes.

Sand

Sand is added to the core of the pipe and the inner layer of couplings.

High silica sand must be within the FLOWTITE specifications for approved raw materials

Accelerator

An accelerator is mixed into the resin stored in the day tanks. It may be delivered from producers in different concentrations and may be diluted with styrene to reach the required concentration needed for the production of the “FLOWTITE” pipes.

Physical Properties

The manufactured pipe’s circumferential (hoop) and axial load capacities are verified by testing. Pipe stiffness and deflection test are also carried out. All these tests are done on a routine basis according to the FLOWTITE quality manual. In addition, pipe construction and composition are confirmed.

5.5 Finished Pipe

The Flowtite quality control program contains a variety of tests. Pipes can be controlled with tests such as the ones below:

- Visual inspection
- Barcol hardness
- Wall thickness
- Section length
- Diameter
- Hydrostatic leak tightness test
- Pipe stiffness
- Deflection without damage or structural failure
- Axial and circumferential tensile load capacity
- Overall laminate composition

5.6 Qualification Testing

A common element shared by all standards is the need for a pipe manufacturer to demonstrate compliance with the standards’ minimum performance requirements. In the case of GRP pipe, these minimum performance requirements fall into both short-term and long term requirements.

The most important ones, and generally specified at the same level of performance in all the previously defined standards, are joint qualification, initial ring deflection, long term ring bending, long term pressure and strain corrosion capability. FLOWTITE pipes and coupling systems have been rigorously tested to verify conformance to those standards.

Long Term Testing

The standards for fibreglass pipes are set on the assumption that when subjected to stresses the material will be subjected to changes in the mechanical properties. The product design is usually based upon the projected values of the material strength at 50 years. To determine the long term properties of the pipe, at least 18 specimens are prepared and subjected to the tests. Failure up to 10,000 hours with an acceptable spread across time span is needed for evaluation. The results obtained are evaluated using a log-log line projected on to obtain the 50 year value. Over the years a remarkable amount of test results based on the ASTM test method have been collected. Over 600 data-points are recently analysed, with times-to-failure ranging from a few hours up to 28 years. Analysis of the data demonstrates an interesting bilinear behaviour, rather than the straight line regression predicted by the shorter and smaller database. The results suggests that the standardized method is indeed quite conservative and that with this additional information the safety margins are shown to be higher than expected and extrapolation even up to 150 years could be achieved. FLOWTITE GRP pipes meet herewith the requirements of some institutions requesting a pipe life cycle of more than 100 years.

Strain Corrosion Testing

A unique and important performance requirement of GRP gravity pipes used in sewer applications is the chemical testing of the pipe in a deflected or strained condition. This strain corrosion testing requires a minimum of 18 ring samples of the pipe to be deflected to various levels and held constant. These strained rings are then exposed at the inversion of the interior surface to 1.0N (5% by weight) sulphuric acid. This is intended to simulate a buried septic sewer condition. This has been shown to

be representative of the worst sewer conditions, including those found in the Middle East, where many FLOWTITE pipes have been successfully installed.

The time to failure (leakage) for each test sample is measured. The minimum extrapolated failure strain at 50 years, using a least squares regression analysis of the failure data, must equal the values shown for each stiffness class according to the standard. The value achieved is then related to the pipe design to enable the prediction of safe installation limitations for GRP pipes used for this type of service. Typically this is 5% in-ground long term deflection.

For example, according to ASTM standards the minimum strain corrosion value must be:

Stiffness Class	S _{cv} Strain, %
SN 2500	.49 (t/d)
SN 5000	.41 (t/d)
SN 10000	.34 (t/d)

Table 5-6-1 Minimum Strain Corrosion Value

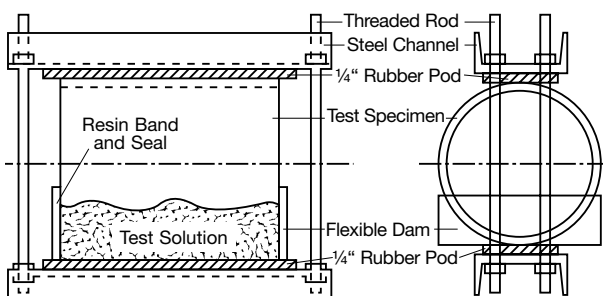

Figure 5-6-1 Strain Corrosion Test Apparatus

The fifty year predicted strain corrosion value as published by FLOWTITE is 0.67%.

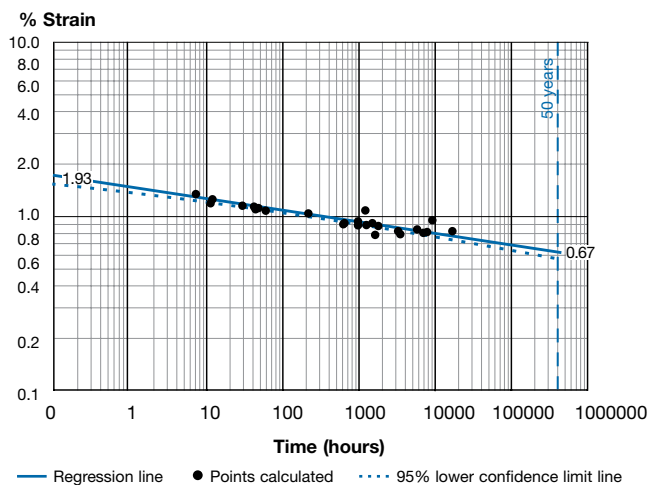

Figure 5-6-2 FLOWTITE Line for Strain Corrosion

Hydrostatic Design Basis – HDB

Another important qualification test is the establishment of the Hydrostatic Design Basis – HDB. This test requires hydrostatic pressure testing to failure (leakage) of many pipe samples at a variety of very high constant pressure levels. As in the previously described strain corrosion test, the resulting data is evaluated on a log-log basis for pressure (or hoop tensile strain) vs. time to failure and then extrapolated to 50 years.

The extrapolated failure pressure (strain) at 50 years, referred to as the hydrostatic design basis (strain) or HDB, must be greater than pressure class (strain at the rated pressure) according to the safety factor (see Figure 5-6-2). Due to combined loading considerations, that is the interaction of internal pressure and external soil loads; the actual long term factor of safety against pressure failure alone is higher than this safety factor. This qualification test helps assure the long term performance of the pipe in pressure service.

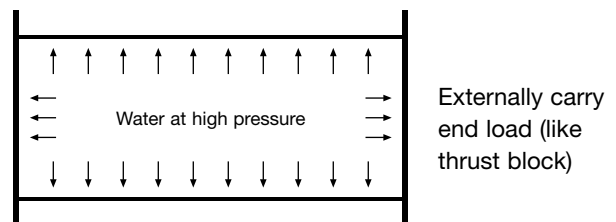

Figure 5-6-3 Effect of Long Term Pressure on Pipe Life

The fifty year predicted HDB strain value as published by FLOWTITE is 0.65%.

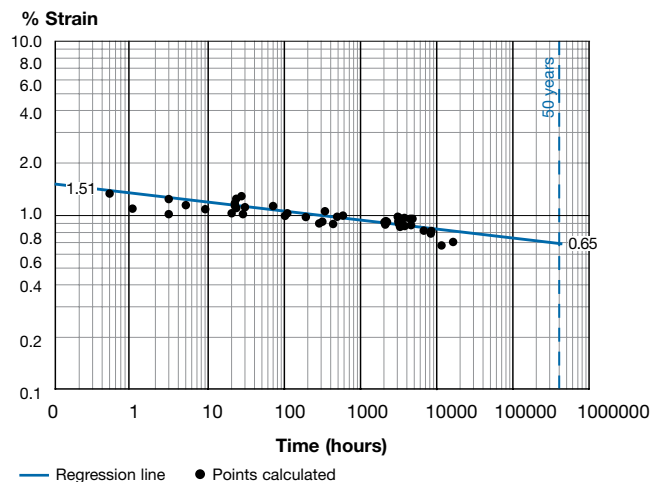

Figure 5-6-4 FLOWTITE Line for Long Term Pressure Strain

Long Term Ring Bending

A GRP pipe's long term (50 year) ring deflection or ring bending (strain) capability, when exposed to an aqueous environment and under a constant load, must meet the Level A deflection level specified in the initial ring deflection test. This requirement is defined in the ISO and EN standards. AWWA C950 requires the test to be carried out, with the resulting 50-year predicted value used in the pipe's design. FLOWTITE pipe is tested using the guidelines of ASTM D5365 "Long Term Ring Bending Strain of Fibreglass Pipe" and meets all requirements.

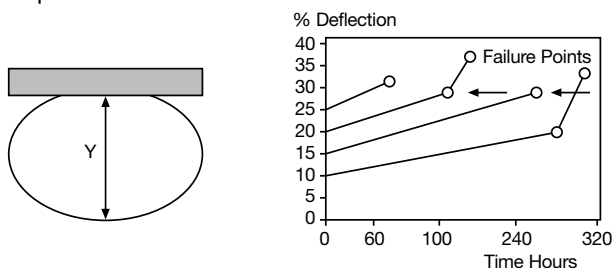

Figure 5-6-5 Effect of Long Term Bending in Water in Pipe Life

The fifty year predicted long term bending as published by FLOWTITE is 1.3%.

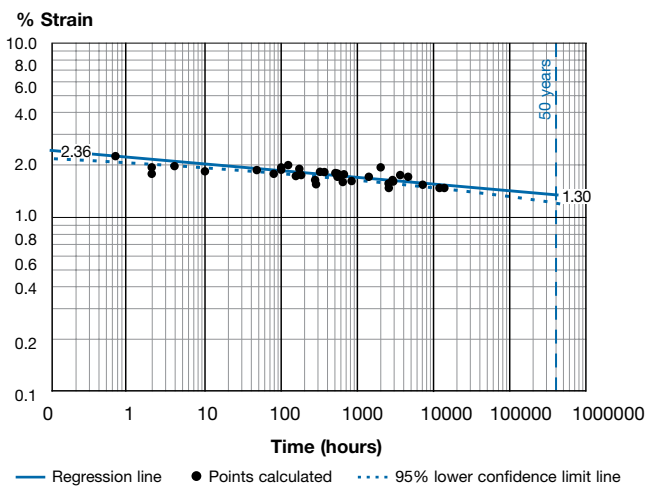

Figure 5-6-6 FLOWTITE Line for Long Term Bending

Long Term Stiffness – Material Creep

The long term stiffness of FLOWTITE pipes has been determined by conducting a test program following the guidelines of ISO 10468 and analysed according to ISO 10928, method B. Two pipe samples with an initial stiffness of 5800 Pa were tested and the average creep factor and 50 year stiffness computed. The creep factor is the ratio between 50 year specific ring stiffness and the initial stiffness. The average creep factor found in the laboratory tests was 0,75. This results in a long

term stiffness of SN5000 pipe thus be equal to 3750 Pa and allows using a long term stiffness factor higher than 60% of initial stiffness in static calculations.

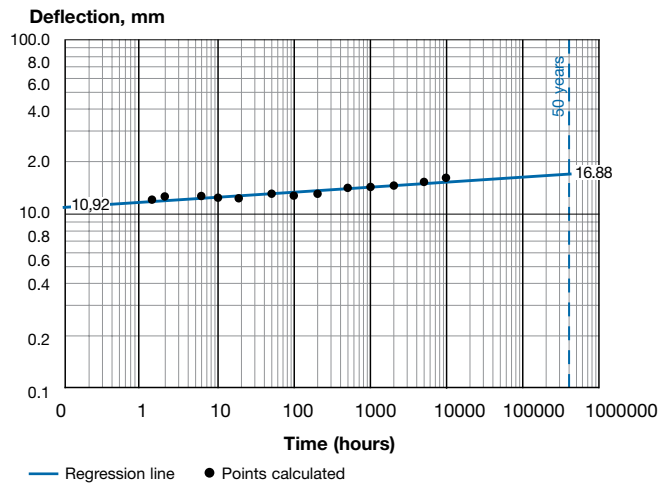

Figure 5-6-7 Long Term Stiffness SN 5000 PN 16

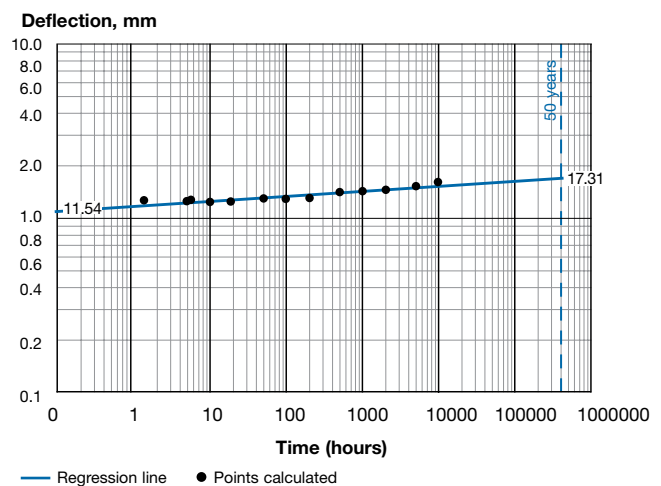

Figure 5-6-8 Long Term Stiffness SN 5000 PN 6

Joint Testing

This important qualification test is conducted on joint prototypes of elastomeric gasket sealed couplings. This test is carried out in accordance with ASTM D4161, EN 1119 and ISO 8639. It incorporates some of the most stringent joint performance requirements in the piping industry for pipe of any material within the pressure and size ranges of FLOWTITE pipe. These standards require that flexible joints withstand hydrostatic testing in configurations that simulate n-use conditions. Tests are performed at pressures twice those rated and 1 bar is used for gravity flow pipe. Joint configurations include straight alignment, maximum angular rotation and differential shear loading. A partial vacuum test and cyclical pressure tests are also included. The long term qualification test results are used for designing the pipes as indicated in the international standards.

6 Underground Pipe System Design

- 01
- 02
- 03
- 04
- 05
- 06
- 07
- 08
- 09
- 10
- 11
- 12

ANSI/AWWA Standard C950-95 and AWWA Manual M45 are the basic references for FLOWTITE underground design procedure. Our cost free electronic AMISTAT tool is designed to support clients in doing calculations acc. to AWWA M45 and ATV 127. Fibreglass pipes are flexible and can sustain large deformation. Vertical loads (soil, traffic and water table) determine a deflection depending on soil compaction around the pipe and on ring stiffness of the pipe cross section.

FLOWTITE pipes are flexible in most soils. Special attention needs to be given to the digging, side filling and backfilling of the trench. This provides the necessary support of the pipe. It also prevents distortion and possible damage by the soil and/or traffic. Resistance to horizontal movement of the pipe depends on the soil type, its density and moisture content. The greater the soil resistance, the less the pipe will deform or move.

The following figure shows the load distribution and mobilisation of soil reaction, caused by soil compression in interaction with the pipe's flexibility and deformation.

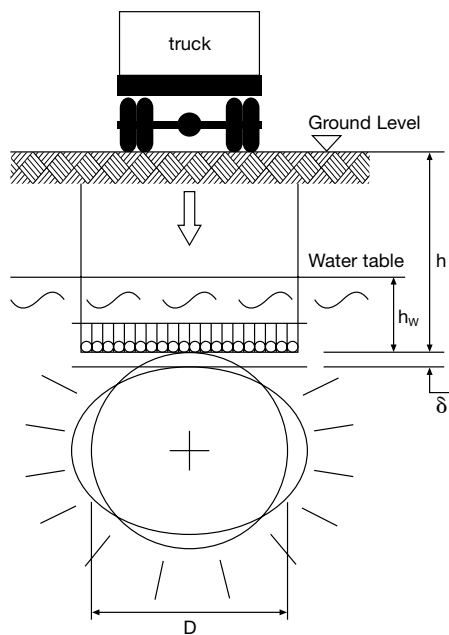

Figure 6-1 Pipe Behavior under Traffic Load

As the design is based on AWWA M-45, we are now enclosing a summary of chapter 5 of the said standard. The GRP pipes, as they are flexible pipes, will deflect and by that distribute the soil load to the stronger side fill material. The consequences are as follows:

- The side fill material has to carry the loading from backfill, traffic, etc.
- The pipe gets less load.
- The pipe can concentrate on its purpose, the leak free transport of the fluids.

Rigid pipes are always stronger and stiffer than the soils, therefore the load concentrates on the pipe. The pipe has to carry this loading even over long times. And with later soil movements, this loading may increase further.

The flexible pipes will react dynamically, deflect and transfer the loads to the side fill.

The soil will settle to carry the load.

Studies in sewer and pressure lines shows that the rate of failure in rigid pipes is more than in flexible pipes. A calculation based on Procter Ashland is available on request.

6.1 Static Calculation Methods of Underground Pipe System

6.1.1 Summary of AWWA Design Chapter AWWA M-45

The AWWA C-950-86 was revised and divided into 2 parts:

- C950 This is now a performance standard like ASTM
- AWWA M-45 This is now a design manual. Chapter 5 gives the design method for underground fibreglass pipes

Design Calculations

- Calculate the pressure class

$$P_c \leq \frac{HDB \cdot 2 \cdot t \cdot E_n}{FS \cdot D}$$

E_n = The tensile modulus of the structural layer
 t = reinforced thickness of the pipe

The project pressure should be less than P_c ; $P_w \leq P_c$

P_w = Working pressure or the design pressure

- Surge Pressure

The surge pressure is 40% of P_w so

$$P_c \geq \frac{P_w + P_s}{1.4}$$

Ring Bending

$$\epsilon_b = D_f (Dy/D) * (t_f/D) \leq (S_b/FS)$$

D_f is the deflection lag factor
 Dy/D allowable long term deflection
 S_b Long term bending strain for pipe
 FS Factor of safety = 1.5
 ϵ_b = maximum ring bending strain due to deflector

The deflection is calculated as shown below:

$$Dy/D = \frac{(D_L * W_c + W_L) * K_x}{(149 * P_s + 6100 * M_s)}$$

W_c : vertical soil load $N/m^2 = \gamma_s * H$; where γ_s is the unit weight of soil and H is the burial depth
 W_L : Live load on the pipe.
 M_s = composite soil constrained modulus
PS pipe stiffness and not STIS

D_L = Deflection lag factor usually taken at 1.5
 K_x = Bedding coefficient usually taken as 0.1
 To determine the value of M_s , separate values of M_{sn} for native soil and M_{sb} for backfill should be determined and then combined.
 $M_s = S_c * M_{sb}$
 S_c = Soil support
 M_{sb} = Constraint modulus of the pipe zone embedment
 M_{sn} = Constraint modulus of native soil

Combined Loading

Combined loading is when we combine the bending and the tension. The bending is from deflection and the tension is from pressure

$$\epsilon_{pr} / HDB \leq \{1 - (\epsilon_b * r_c / S_b)\} / FS_{pr}$$

and

$$\epsilon_b * r_c / (S_b) \leq \{1 - (\epsilon_{pr} / HDB) / FS_b\}$$

with $FS_{pr} = 1.8$ and $FS_b = 1.5$

$\epsilon_{pr} = P_w * D / (2 * t * E_r)$ and $\epsilon_b = D_f (\delta d / D) (t_f / D)$
 with $r_c = 1 - P_w / 3000$ where $P_w \leq 3000$ kPa
 $\delta d / D$ = maximum permitted deflection and not the calculated one

Buckling

The allowable buckling pressure is determined q_a is determined by the following equation

$$q_a = \frac{(1.2 * C_n)(EI)^{0.33} (\phi_s * 10^6 * M_s * k_\eta)^{0.667} * R_h}{(FS)r}$$

where

q_a = allowable buckling pressure in kPa
 FS = design factor = 2.5

C_n = scalar calibration factor to account for some non linear effects = 0.55

ϕ_s = factor to account for variability in stiffness of compacted soil; suggested as 0.9

k_η = modulus correction factor for Poisson's ratio, η of the soil = $(1 + \eta)(1 - 2\eta) / (1 - \eta)$

In the absence of specific information, it is common to assume $\eta = 0.3$ then $k_\eta = 0.74$

R_h = correction factor for depth of fill

$$= 11.4 / (11 + D / 1000 * h)$$

with h = height of ground surface above top of pipe

An alternate to equation above is

$$q_a = \left(\frac{1}{FS}\right) [1.2 C_n (0.149 PS)^{0.33}] (\phi_s 10^6 M_s k_\eta)^{0.67}$$

Satisfaction of the buckling requirement is assured for typical pipe installations by using the following equation:

$$[\gamma_w h_w + R_w (W_c)] * 10^{-3} + P_v \leq q_a$$

where:

γ_w = specific weight of water = 9800 N/m³

P_v = internal vacuum pressure (i.e., the atmospheric pressure less absolute pressure inside pipe) in kPa

R_w = water buoyancy factor = $1 - 0.33(h_w/h)$ ($0 \leq h_w \leq h$)

h_w = height of water surface above the pipe top, m

If live loads are considered, satisfaction of the buckling requirement is ensured by:

$$[\gamma_w h_w + R_w (W_c) + W_L] * 10^{-3} \leq q_a$$

Typically live load and internal vacuum are not considered simultaneously.

The document contains different pipe designs, it is advisable that the examples are made manually so that the trainee can have the feeling of this standard. AWWA calculations are based on proctor density. Ashland calculation is available on request.

6.1.2 Summary of ATV-DVWK-A 127

The calculation of the pipe static [design] according to ATV-A 127 can in general be divided into two steps:

- calculation of load distribution around the pipe
- execution of the relevant verifications: deformation-, stability- and elongation verifications

Load distribution around the pipe

$$q_v = \lambda_{PG} \cdot p_E + p_V$$

with

q_v = vertical soil stress on pipe

λ_{PG} = concentration factor above the pipe;

consideration the flexible ($\lambda_{RG} < 1$) or rigid ($\lambda_{RG} > 1$) reaction of the pipe-soil-system

p_E = soil stresses due the earth load

$p_E = \lambda \cdot \gamma_S \cdot h$ with

κ = reduction factor for trench loads into according to Silo Theory

Silo Theory: Friction forces on existing trench walls can lead to a reduction of the ground stress.

γ_S = unit weight of the soil

h = height of the cover above the pipe

p_V = soil stresses due the traffic load

$p_V = \varphi \cdot p$ with

φ = impact coefficient for traffic loads

p = soil stresses due the traffic load

$$q_h = K_2 \cdot (\lambda_S \cdot p_E + \gamma_S \cdot \frac{d_e}{2})$$

with

q_h = horizontal soil stress on pipe

K_2 = ground pressure ratio in soil zones

d_e = external pipe diameter

λ_S = concentration factor in soil adjacent to pipe

$$q_h^* = \frac{c_{n,qv} \cdot q_v + c_{n,qh} \cdot q_h}{V_{RB} - c_{n,qh}}$$

* Indication for the equation number in according to ATV-DVWK-A 127

with

q_h^* = horizontal bedding reaction pressure

$c_{(i)}$ = deformation coefficients addicted to bedding angle

V_{RB} = system stiffness; if $V_{RB} < 1$, the soil-pipe-system is flexible

$V_{RB} = \frac{8 \cdot S_0}{S_{Bh}}$ with

S_0 = pipe stiffness

S_{Bh} = horizontal bedding stiffness

Verification of Deformation

In according to ATV-A 127 the max. long term deformation is the allowable value nec $\delta V = 6\%$. Please consult the supplier for calculation small diameters $DN \leq 250$ and for case $> 5\%$ deflection of diameter. The real deformation can be calculated using the following equation:

$$\delta_v = \frac{\Delta d_v}{d_m} \cdot 100\% <_{nec} \delta_v$$

with

d_m = mean pipe diameter

Δd_v = vertical change of pipe diameter as a result of external loads

$$\Delta d_v = \frac{2 \cdot r_m}{8 \cdot S_0} \cdot (c_{v,qv} \cdot q_v + c_{v,qh} \cdot q_h + c_{v,qh} \cdot q_h)$$

with $c_{(i)}, q_{(i)}$: see above

Verification of Stability

Verification of Stability soil and traffic load

$$\gamma_{qv} = \frac{crit\ q_v}{q_v} >_{nec} \gamma$$

with

nec γ = necessary safety coefficient

q_v = vertical soil stress on pipe, see above

crit q_v = critical vertical total load

$$V_{RB} \leq 0,1: crit\ q_v = 2 \cdot \kappa_{v2} \cdot \sqrt{8 \cdot S_0 \cdot S_{Bh}}$$

$$V_{RB} > 0,1: crit\ q_v = \kappa_{v2} \cdot (3 + \frac{1}{3 \cdot V_{RB}}) \cdot 8 \cdot S_0$$

S_0, S_{Bh}, V_{RB} : see above

κ_{v2} = reduction factor of the critical buckling load

Verification of Stability external water pressure

$$\gamma_{qe} = \frac{crit\ p_e}{p_e} >_{nec} \gamma$$

with

nec γ = necessary safety coefficient

p_e = external water pressure

$p_e = \gamma_w \cdot h_w$ with

γ_w = unit weight of water

h_w = height of water level above the pipe crown

crit p_e = critical external water pressure

$$\text{crit } p_e = \kappa_e \cdot \alpha_D \cdot 8 \cdot S_0 \quad \text{with}$$

κ_e = reduction factor of the critical buckling load

α_D = snap-through coefficient

S_0 = pipe stiffness, see above

Verification of Stability vertical total load and external water pressure (simultaneous influence)

$$\gamma = \frac{1}{\frac{q_{v,A}}{\text{crit } q_v} + \frac{p_e}{\text{crit } p_e}} < \text{nec } \gamma$$

with

nec γ = necessary safety coefficient

$q_{v,A}$ = q_v with max. height of water level above the pipe (take into consideration the buoyancy)

crit q_v , p_e , crit p_e : see above

Verification of Elongation

The verification of elongation has to be calculated separately for the part of the crown, the haunch and the invert and these for the inside and outside of the pipe.

Together you have to do six verifications.

If a higher internal pressure is in the pipe one has to do (not represented here) up to 18 different verifications of elongation (in consideration of the load cases).

$$\gamma = \frac{\varepsilon_P}{\varepsilon} > \text{erf } \gamma$$

With the following values of elongation:

ε measured compression set of the deformation layer

$$\varepsilon = \frac{s}{2 \cdot r_m \cdot 8 \cdot S_0} \cdot \left(\frac{s \cdot N}{6} \pm M \cdot \alpha_C \right)$$

with

N = summary of normal forces

M = summary of bending moments

S_0 = pipe stiffness, see above

s = wall thickness, pipe

α_C = correction factor for curvature

r_m = radius of the centroidal axis of the pipe wall

Information: The forces and moments have to be calculated separately for the part of the crown, the haunch and the invert.

ε_p calculated value of the outer fibre strains

$$\varepsilon_p = \pm 4,28 \cdot \frac{s}{d_m} \cdot \left(\frac{\Delta d_{\text{frac}}}{d_m} \right)$$

with:

s = wall thickness, pipe

d_m = mean pipe diameter

$\frac{\Delta d_{\text{frac}}}{d_m}$ = calculated value of relative fracture deformation

Nominal Ring Stiffness N/m ²	$\Delta d_{\text{frac}} / d_m$ in %	
	short term	long term
SN 2500	25	15
SN 5000	20	12
SN 10000	15	9

Table 6-1-1 Cut Out

ε_p = weighted calculated value of outer fibre elongations

$$\varepsilon_p = \frac{p_E \cdot \varepsilon_{PL} + p_V \cdot \varepsilon_{PK}}{p_E + p_V}$$

with:

ε_{PL} = calculated long term value of outer fibre strains

ε_{PK} = calculated short term value of outer fibre strains.

p_E = soil stresses due the earth load, see above

p_V = soil stresses due the traffic load, see above

Coefficient to safety

The necessary global safety coefficient of the safety class A (rule) nec γ for the verification of elongation of glass fibre reinforced pipes in according to ATV-DVWK-A 127 nec $\gamma = 2.0$.

If preliminary deformation with reduction factor of the critical buckling (κ_{v2} and κ_e) is taken into account, the necessary global safety coefficient of stability in according to ATV-DVWK-A 127 is nec $\gamma = 2,0$ too.

6.2 Buoyancy

If the water table (or level) is at ground level then a check for buoyancy effects is required. The combined load, F_{down} , (N/m) due to the sum of loads, weight of the soil, W_s , (N/m) plus weight of pipe, W_p , (N/m) and its contents, W_i , (N/m) has to be greater than the upwards buoyancy force, F_{up} , i.e.

$$W_s + W_p + W_i = F_{down}$$

where

$$W_s = OD \cdot \gamma_s \cdot \left(1 - \frac{h_w}{3h}\right)$$

$$\text{and } F_{down} \geq F_{UP}$$

where

$$F_{UP} = \frac{\pi}{4} \cdot OD^2 \cdot \gamma_w$$

In the above,

h_w = height of water above top of pipe (m)

h = height of soil above top of pipe (m)

γ_w = specific water density (kg/m³)

6.3 Hydro-Testing

Maximum Factory Test Pressure 2.0 x PN (Pressure Class)

Maximum allowable Field Test Pressure for pipes is 1.5 x PN (Pressure Class)

Pressure and diameter upper limit are functions of the hydrotest capacity in the plants. The field practice according to standards defines the field test pressure as

$$N \times \text{Working Pressure}$$

with "N" varying from 1.2 – 1.5 according to standards.

6.4 Surge and Water Hammer

Water hammer or pressure surge is the sudden rise or fall in pressure caused by an abrupt change in the fluid velocity within the pipe system. The usual cause of these flow changes is the rapid closing or opening of valves or sudden starting or stopping of pumps such as during a power failure. The most important factors which influence the water hammer pressure in a pipe system are the change in velocity of the fluid, rate of change of the velocity (valve closing time), compressibility of the fluid, stiffness of the pipe in the circumferential "hoop" direction and the physical layout of the pipe system.

The water hammer pressure expected for FLOWTITE pipe is approximately 50% of that for steel and ductile iron pipe under similar conditions. FLOWTITE pipe has a surge pressure allowance of 40% of the nominal pressure. An approximate relationship for the maximum pressure variation at a given point in a straight pipeline with negligible friction loss can be calculated with the formula:

$$\Delta H = (w \Delta v) / g$$

where:

ΔH = change in pressure (meters)

w = surge wave celerity (meters/sec)

Δv = change in liquid velocity (meters/sec)

g = acceleration due to gravity (meters/sec²)

DN	300-400	450-800	900-2500	2800-3000
SN 2500				
PN 6	365	350	340	330
PN 10	435	420	405	390
PN 16	500	490	480	470
SN 5000				
PN 6	405	380	370	360
PN 10	435	420	410	
PN 16	505	495	480	
PN 25	575	570	560	
SN 10000				
PN 6	420	415	410	400
PN 10	435	425	415	
PN 16	500	495	485	
PN 25	580	570	560	
PN 32	620	615	615	

Table 6-4-1 Surge Wave Celerity for FLOWTITE Pipes (meters/sec.)

DN	100	125	150	200	250
SN 10000					
PN 6	580	560	540	520	500
PN 10	590	570	560	540	520
PN 16	640	620	610	600	590

Table 6-4-2 Surge Wave Celerity for Small Diameter Pipes

Note: There has been some rounding, within 2%, in the above values. Please contact your FLOWTITE supplier if more accurate values are required for a transient analysis.

6.5 Load Capacity Values

For design purposes the following values can be used for hoop tensile and axial tensile load capacity.

DN	PN1	PN6	PN10	PN16	PN20	PN25	PN32
300	60	360	600	960	1200	1500	1920
350	70	420	700	1120	1400	1750	2240
400	80	480	800	1280	1600	2000	2560
450	90	540	900	1440	1800	2250	2880
500	100	600	1000	1600	2000	2500	3200
600	120	720	1200	1920	2400	3000	3840
700	140	840	1400	2240	2800	3500	4480
800	160	960	1600	2560	3200	4000	5120
900	180	1080	1800	2880	3600	4500	5760
1000	200	1200	2000	3200	4000	5000	6400
1100	220	1320	2200	3520	4400	5500	7040
1200	240	1440	2400	3840	4800	6000	7680
1400	280	1680	2800	4480	5600	7000	8960
1600	320	1920	3200	5120	6400	8000	10240
1800	360	2160	3600	5760	7200	9000	11520
2000	400	2400	4000	6400	8000	10000	-
2200	440	2640	4400	7040	8800	11000	-
2400	480	2880	4800	7680	9600	12000	-
2600	520	3120	5200	8320	10400	-	-
2800	560	3360	5600	8960	11200	-	-
3000	600	3600	6000	9600	12000	-	-

Table 6-5-1 Hoop Tensile Load Capacity

Minimum initial hoop (circumferential) load, N per mm of length.

DN	PN1	PN6	PN10	PN16	PN20	PN25	PN32
300	95	115	140	150	170	190	220
350	100	125	150	165	190	215	255
400	105	130	160	185	210	240	285
450	110	140	175	205	235	265	315
500	115	150	190	220	250	290	345
600	125	165	220	255	295	345	415
700	135	180	250	290	340	395	475
800	150	200	280	325	380	450	545
900	165	215	310	355	420	505	620
1000	185	230	340	390	465	560	685
1100	195	245	360	420	505	600	715
1200	205	260	380	460	560	660	785
1400	225	290	420	530	630	760	1015
1600	250	320	460	600	820	918	1108
1800	275	350	500	670	912	1023	1237
2000	300	380	540	740	1003	1126	-
2200	325	410	595	883	1095	1229	-
2400	350	440	620	1063	1186	1332	-
2600	375	470	956	1144	1276	-	-
2800	410	510	1022	1225	1376	-	-
3000	455	545	1090	1306	1458	-	-

Table 6-5-2 Axial Tensile Load Capacity

Minimum initial axial (longitudinal) load, N per mm of circumference.

6.6 Flow Velocity

The recommended flow velocity for GRP pipes is 3.0m/sec. Depending on the transported fluid in the pipe, higher flow velocities are possible and accepted.

6.7 UV Resistance

There is no ultraviolet degradation that affects the long term service life of FLOWTITE pipes. The outermost surface will be affected, and discolouring of the surface can be observed. If so desired, the installing contractor may paint the exterior surface of FLOWTITE pipe. However, this will then become an item requiring future maintenance. With its long and vast experience in the Middle East under humid, desert conditions and in Scandinavia in alternating dark and cold winters and the use of above ground pipes for more than 30 years, FLOWTITE does not have any evidence of a structural effect of the radiation on the pipes

6.8 Poisson's Ratio

Poisson's ratio is influenced by the pipe construction. For FLOWTITE pipe, the ratio for hoop (circumferential) loads and axial response ranges from 0.22 to 0.29. For axial loading and circumferential response Poisson's ratio will be slightly less.

6.9 Temperature

Depending on the operating temperature and the type of resin used in the production of the pipes and fittings, the pressure class may be affected at high temperatures. For details please contact your local manufacturer. Special tailormade solutions for high temperature applications are available on request.

6.10 Thermal Coefficient

The thermal coefficient of axial expansion and contraction for FLOWTITE pipe is 24 to 30 x 10⁻⁶ cm/cm/°C.

6.11 Flow Coefficients

Based on tests carried out in existing installations on FLOWTITE pipe, the Colebrook-White coefficient may be taken as 0.029 mm. This corresponds to a Hazen-Williams flow coefficient of approximately $C=150$. The Manning coefficient $n = 0.009$

To assist the designer with estimating the head-loss associated with using FLOWTITE pipe, figures below have been provided.

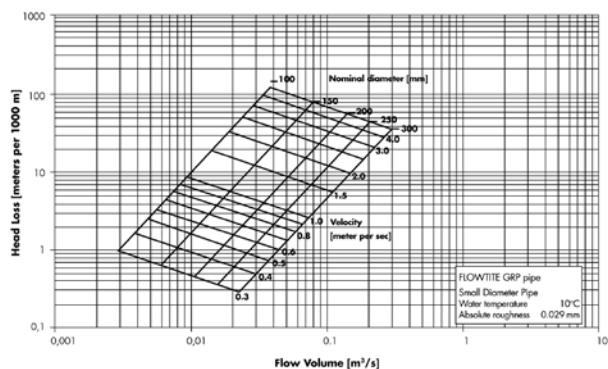

Figure 6-11-1 Head Loss – Small Diameters

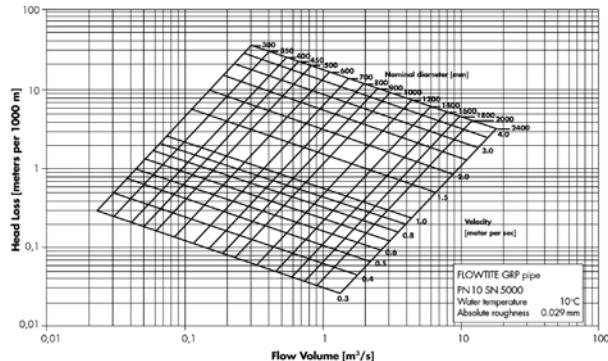

Figure 6-11-2 Head Loss – Large Diameters

6.12 Abrasion Resistance

Abrasion resistance can be related to the effects that sand or other similar material may have on the interior surface of the pipe. While there is no widely standardised testing procedure or ranking method, FLOWTITE pipe has been evaluated by using the Darmstadt Rocker method. Results are highly influenced by the type of abrasive material used in the test. Using gravel which was obtained from the same source as that used at Darmstadt University, the average abrasion loss of FLOWTITE pipe is 0.34 mm at 100,000 cycles.

6.13 External Collapse Pressure

Where pipes may be exposed to external pressure, such as in tanks, buoyant systems, subsea etc., the resistance against collapse may become important.

Minimum Ultimate collapse pressure in bars

$$P_B = 2.5 \frac{E_H}{1 - \mu_{xy} \mu_{yx}} \left(\frac{t}{r_m} \right)^3$$

The buckling pressure uses the formula for thin wall pipes ($r/t > 10$). It is also depending on the diameter/spacing of stiffeners ratio.

Note: Using 75% of the minimum ultimate collapse pressure as external pressure rating is generally well accepted for industrial usage.

For pipes used in marine environments, such as at bottoms of sea going vessels, use 30% of the minimum ultimate collapse pressure.

6.14 Hydraulics

FLOWTITE pipes have a lot of hydraulic features which ultimately lead to reduced pressure drop, minimise pumping energy and also enhance the pipeline flow.

The flow characteristics of FLOWTITE pipes can be compared to steel in various ways.

6.15 Liquid Flow

FLOWTITE pipes provide several advantages over metallic non-metallic pipes, these advantages are:

- Smooth inner surface, results in less pressure drop or less required pumping pressure. This leads to substantial cost savings.
- The inner surface remains smooth over the service life of the pipeline, leads to constant pressure drop.
- FLOWTITE inner diameter is larger than steel or thermoplastic pipes, leads to higher flow capacity, lower flow velocity and lower pressure drop.

6.15.1 Pressure Reduction

The smooth interior of FLOWTITE pipes compared to steel is a great advantage in reducing the pressure drop.

For many years water engineers have used the Hazen Williams's factor as an indication of the smoothness and good performance of pipes.

FLOWTITE Hazen William factor = 150

FLOWTITE pipes have another advantage in that the inner surface roughness does not change with time. Steel or ductile inner surface roughness increases with time due to internal corrosion and chemical attack, which is not the case with FLOWTITE pipes.

6.15.2 Pressure Drop/Loss Calculations

All methods and formulas used for metallic pipes can also be used for FLOWTITE, taking into consideration characteristics such as smooth inner surface, dimensions and material properties.

Hazen-Williams equation.

Applicable to water pipes under conditions of full turbulent flow

$$h_f = 240 \cdot 10^6 (100/C)^{1.85} (Q^{1.85}/d^{4.87})$$

where h_f = friction factor m of water/100 m
 Q = flow rate in l/sec
 ID = pipe inner diameter, meter
 C = Hazen-Williams roughness coefficient
 = 150 (typical value for fibreglass pipes)
 L = Pipe line length, m

The head loss for any liquid

$$P = (h_f)(SG)/0.102$$

where P = pressure loss, kPa
 SG = Specific gravity of the liquid

6.15.3 Manning Equation

The Manning equation is used for water pipes with partial flow. This is normally the case in gravity flow, drainage lines and sewage applications where the pipeline is under the influence of an elevation head only.

$$Q_m = (1000/n) (S)^{0.5} (A) R^{0.667}$$

where Q_m = Flow rate, l/sec
 S = Hydraulic gradient of slope = $(H_1 - H_2)/L$
 H_1 = Upstream elevation, m
 H_2 = Downstream elevation, m

L = Length of pipeline, m
 A = Cross section area of pipes, m^2
 R = Hydraulic radius, $m = A/W_p$
 W_p = Wetted perimeter of pipe, m
 n = Manning roughness factor
 = 0.009 for typical fibreglass pipe.

6.15.4 Fluid Pipeline Equations

General Equation Darcy-Wesibach equation
 The Darcy-Wesibach equation applies to all fluids at full flow pipe.

$$H_f = fL (v^2)/2(ID) g$$

where H_f = Pressure drop, Pa (N/m^2)
 g = gravitational constant = $9.81 m/sec^2$
 f = friction factor
 L = Pipeline length, m
 v = Fluid velocity, m/s
 ID = Pipe inner diameter, m

6.15.5 Friction Factor Formulas

Friction factor is a function of the following:

Fluid density
 Pipe inner diameter
 Fluid velocity
 Fluid dynamic viscosity

These four characteristics in sum is what is called R_e (Reynolds number)

$$R_e = \frac{vID}{\mu}$$

where v = Fluid velocity, m/s
 ID = Pipe inner diameter, m
 μ = Fluid dynamic viscosity, Ns/m^2 (Pa s)

If $R_e < 2000$ Flow is laminar, then

$$f = \frac{64}{R_e}$$

If $R_e > 4000$ Flow is turbulent, then

$$1/f_t^{0.5} = -2\log((e/ID)/3.7) + 2.51/(R_e)(f_t^{0.5})$$

where f = friction factor
 K = absolute inner surface roughness, m
 ID = inner pipe diameter, m
 R_e = Reynolds number

This equation requires a trial and error iterative solution. One simplification to this formula with accuracy within 1% is:

$$f_t = (1.8 \log(R_e/7))^{-2}$$

6.15.6 Pressure Drop in Fittings

Total head loss in the fittings can be calculated using the following equation

$$= \text{Sum } K \cdot (v^2/2g)$$

where k = resistance coefficient for each fitting type and configuration
 V = flow velocity in the pipeline, m/s

6.15.7 Darcy Equation for „Minor Losses“

To calculate losses in piping systems with both pipe friction and minor losses use

$$(\text{Sum } K + f_t (L/ID))(v^2/2g)$$

where $\Sigma(k)$ = the sum of the „k“ friction factors for the fittings in the pipe
 V = flow velocity
 g = gravitational constant

Description	K factors
90 degree, standard elbow	0.400*
0-30 degree, single miter	0.150*
45-60 degree, double miter	0.240*
Tee, straight flow	0.400*
Tee, flow to branch	1.400*
Tee, flow from branch	1.700*
Reducer single size reduction	0.075*
Reducer double size reduction	0.075**

Table 6-15-1 Friction Factor for Segmented Fittings

* evaluated ** AWWA

7 Product Range

FLOWTITE pipe systems are supplied in nominal diameters ranging from DN 100 up to DN 4000 mm. Larger and intermediate diameters are also available on request.

The standard diameter range in mm is defined as below:

100 · 150 · 200 · 250 · 300 · 350 · 400 · 450 · 500 · 600 · 700 · 800 · 900 · 1000
 1100 · 1200 · 1400 · 1600 · 1800 · 2000 · 2200 · 2400 · 2600 · 2800 · 3000

The locally manufactured standard diameter range varies according to manufacturing facilities. For detailed information, please do not hesitate to contact your contact person on site. Larger diameters than DN 3000 up to 4000 mm and other diameters are available on request.

7.1 Stiffness Classes

The stiffness of a pipe indicates the ability of the pipe to resist external load, and negative pressures. It is an indication of its rigidity.

It is a measured resistance of a deflection of a ring sample by testing in accordance with international standards. It is the value obtained by dividing the force needed to deflect the specimen by 3% (ISO standard) per unit length of the specimen. The CEN and the ISO standards define stiffness by the following:

$$S = \frac{EI}{d_m^3}$$

where

S = the pipe stiffness as determined by testing
 E = the apparent modulus of elasticity
 I = the second moment of inertia, it is the second moment of area per unit length of pipe wall section in m^4 per m

$$I = \frac{t^3}{12}$$

where t = thickness of the pipe.

According to the American standards ASTM, the stiffness is measured at 5% and expressed as $\frac{F}{\Delta_y}$ in psi it is the pipe stiffness and not the Specific Tangential Initial Stiffness “S” mentioned earlier where F = Load per unit length in pounds per inch Δ_y is the vertical deflection in inches
 FLOWTITE pipe systems show the following specific initial stiffness (EI/D^3) expressed in N/m^2 .

8 Pipe Joining

Stiffness Class SN	Stiffness (N/m ²)	Stiffness (ASTM) (psi)
2500	2500	18
5000	5000	36
10000	10000	72

Table 7-1-1 Standard Stiffness Classes

Other stiffness classes are available on request. We also supply custom-designed pipe systems with a stiffness tailored to the needs of the project.

7.2 Pressure

Our FLOWTITE pipes can be supplied in the pressures classes listed below:

Pressure Class PN	Pressure Rating Bar	Upper diameter limit
1 (gravity)	1	3000
6	6	3000
10	10	3000
16	16	3000
20	20	3000
25	25	2400
32	32	1800

Table 7-2-1 Standard Pressure Classes

Not all pressure classes are locally available in all diameters and stiffness. For detailed information, please do not hesitate to contact your local FLOWTITE pipe manufacturer or the AMIANTIT Group. Custom-designed pipes with pressure tailored to the needs of the project are also available.

The pipe's pressure ratings have been established in accordance with the design approach outlined in international standards. Pipes are pressure rated at full operating pressure, even when buried to the maximum depth recommended and taking into account the combined load approaches stated in those standards.

7.3 Lengths

The standard length of FLOWTITE is 6 or 12m. Individually tailored lengths up to 24 meters are also available on request. Diameters smaller than 300 mm are only available in 6 meter standard lengths. FLOWTITE pipe systems can also be supplied in other lengths for special orders.

FLOWTITE pipe sections are typically joined using FLOWTITE GRP couplings. All FLOWTITE GRP pipe solutions have a proven joining system that secures the systems work through its whole estimated service life. The system also offers solutions for transitions to other materials such as connection to valves or other accessories. The pipes are typically joined using FLOWTITE GRP couplings based on the REKA system. Pipes and couplings can be alternatively supplied separately or pre-assembled at one of the female pipe ends. The couplings have an elastomeric sealing gasket (REKA system) based in a precision-machined groove. They also include a stopper in the middle of the coupling. The REKA gasket system has been proven in use for more than 75 years.

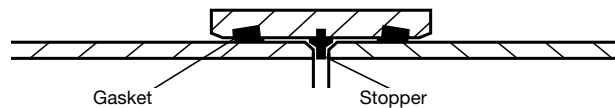

Figure 8-1 Standard GRP Coupling

Pressure pipes systems with unbalanced and axial thrust forces need support by thrust blocks or by the use of restrained jointing systems. For standard pipe systems, thrust blocks are used to transfer the forces to the soil. Another method involves using biaxial pipes and/or key lock joint systems which reliably absorb the axial forces. This often supersedes the installation of concrete blocks and makes the investment more time- and cost-effective.

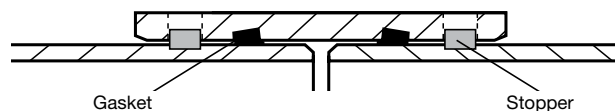

Figure 8-2 Standard Lock Joint

Joint Angular Deflection

The joint is extensively tested and qualified in accordance with ASTM D4161, ISO DIS8639 and EN 1119. Maximum angular deflection (turn) at each coupling joint, measured as the change in adjacent pipe centre lines, must not exceed the amounts given in table below.

! Note: The angular deflection is specified as total deflection including the deflection due to settlement. Use 50-70% of the value in initial installation.

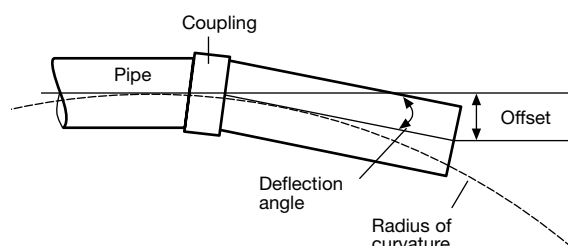

Figure 8-3 Offset and Radius of Curvature

Nom. Pipe Diameter (mm)	Pressure (PN) in bars			
	Up to 16	20	25	32
		Max. Angle of Deflection (deg)		
DN ≤ 500	3.0	2.5	2.0	1.5
500 < DN ≤ 800	2.0	1.5	1.3	1.0
900 < DN ≤ 1800	1.0	0.8	0.5	0.5
DN > 1800	0.5	NA	NA	NA

Table 8-1 Max. Angular Deflection in soft soil at Double Coupling Joint

Angle of Deflection (deg)	Maximum Offset (mm) Pipe length			Radius of Curvature (m) Pipe length		
	3 m	6 m	12 m	3 m	6 m	12 m
3.0	157	314	628	57	115	229
2.5	136	261	523	69	137	275
2.0	105	209	419	86	172	344
1.5	78	157	313	114	228	456
1.3	65	120	240	132	265	529
1.0	52	105	209	172	344	688
0.8	39	78	156	215	430	860
0.5	26	52	104	344	688	1376

Table 8-2 Offset and Radius of Curvature

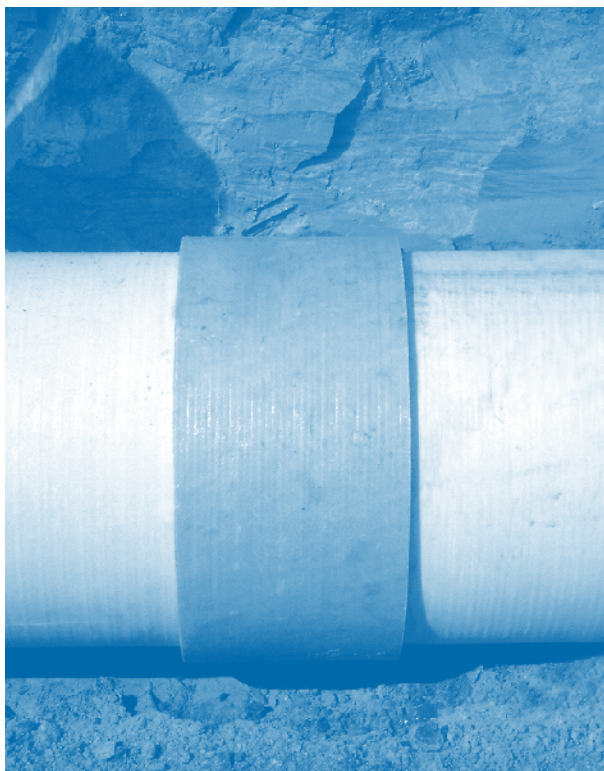

8.1 Other Joining Systems

GRP Flanges

The standard bolt pattern to which our flanges are manufactured is in accordance with ISO2084. Other bolting dimension systems such as AWWA, ANSI, DIN and JIS can also be supplied. Loose and fixed flanges are available for all pressure classes. Contact moulded flanged joints

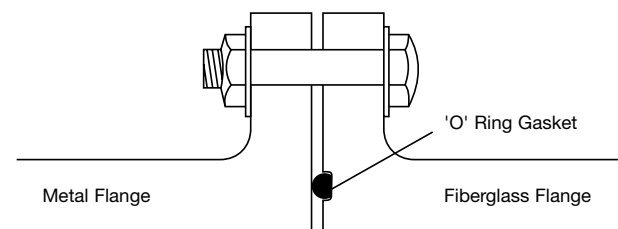

Figure 8-1-1 Flanged Joint

Fixed flange joints

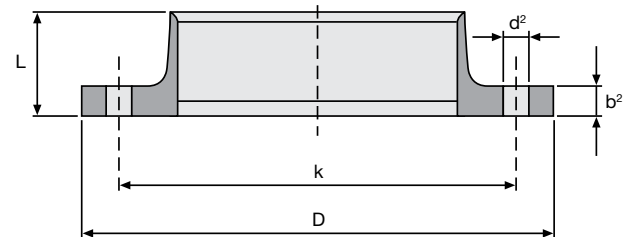

Figure 8-1-2 Fixed Flanged Joint

Loose ring flange

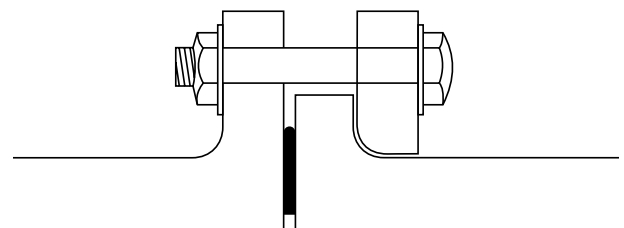

Figure 8-1-3 Loose Ring with Flat Gasket incl. Steel Support

Mechanical Steel Couplings

When connecting FLOWTITE pipe to other materials with different outside diameters, flexible steel couplings are one of the preferred joining methods. These couplings consist of a steel mantle with an interior rubber sealing sleeve. They may also be used to join FLOWTITE pipe sections together, for example in a repair or for closure. Three grades are commonly available:

- Coated steel mantle
- Stainless steel mantle
- Hot dip galvanised steel mantle

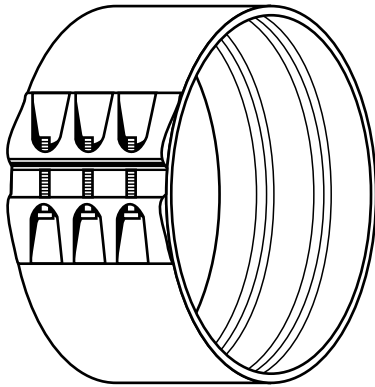

Figure 8-1-4 Flexible Mechanical Joint

Mechanical couplings have been used to join pipes of different materials and diameters, and to adapt to flange outlets. FLOWTITE Technology has found a wide manufacturing variance in these couplings, including bolt size, number of bolts and gasket design which makes standardised recommendations impossible. If a mechanical joint is used to join FLOWTITE to another pipe material then a dual independent bolting system allows for the independent tightening of the FLOWTITE side, which typically requires less torque than recommended by the coupling manufacturer

If the installer intends to use a specific design (brand and model) of mechanical coupling, he is advised to consult with the local FLOWTITE pipe supplier prior to its purchase. The pipe supplier can then advise under what specific conditions, if any, this design might be suitable for use with FLOWTITE.

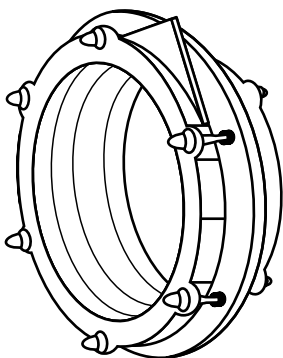

Figure 8-1-5 Dual Bolt Mechanical Coupling

Laminated Joints (Butt strap)

Laminated Joints are typically used where the transmission of axial forces from internal pressure is required, or as a repair method. The length and thickness of the lay-up depends on diameter and pressure.

Detailed information about the local availability of joints and joining systems can be requested from your local supplier.

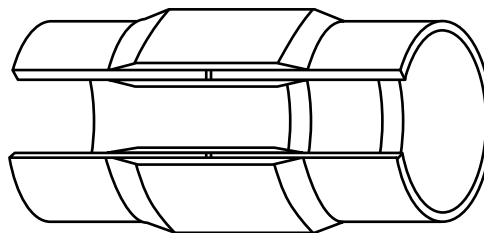

Figure 8-1-6 Laminated Joint

9 Pipe Classification Selection

The selection of FLOWTITE pipe is based on stiffness and pressure class requirements. The GRP is a flexible material. The design is based on an interaction of the pipe and soil support. Unlike concrete and other rigid material, the design of the pipe takes into account the native soil and the backfill. The flexibility of the pipe, combined with the natural structural behaviour of soils, provides an ideal combination for transferring vertical load. Unlike stiff pipes, which would break under excessive vertical load, the pipe's flexibility combined with its high strength allows it to bend and redistribute the load to the surrounding soil.

Rigid vs Flexible Conduits

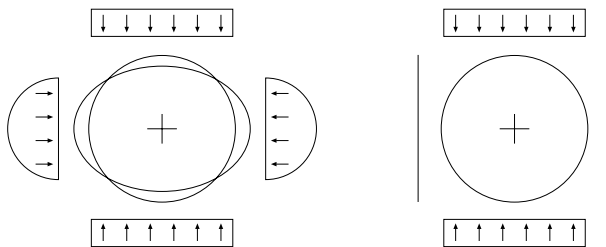

Figure 9-1 Flexible Conduit

Rigid Conduit

Stiffness

The stiffness of FLOWTITE pipe is selected from one of the three stiffness classes listed below. The stiffness class represents the pipe's minimum initial specific stiffness (EI/D^3) in N/m^2 .

SN	N/mm^2
2500	2500
5000	5000
10000	10000

Table 9-1 Stiffness Class

Stiffness is selected according to two parameters. These are: (1) burial conditions, which include native soil, type of backfill and cover depth and (2) negative pressure, if it exists.

The native soil characteristics are rated according to ASTM D1586 Standard Penetration Test. Some typical soil blow count values relative to soil types and density are given in **Table 9-2**.

A wide range of backfill soil types are offered in **Table 9-3** to allow each installation to be customised providing the most economical installation. In many instances, the native trench soils can be used as pipe zone backfill.

Assuming standard trench construction, and an allowable long term deflection of 5% for pipe diameters 300 mm and larger, and 4% for smaller diameters, the maximum allowable cover depths, with consideration for traffic loads, for the three different stiffness classes in the six native soil groups are given the "FLOWTITE Instruction for buried pipes".

The correlation between the backfill soil classification, the native soil groups, pipe stiffness and burial depth is given in the "FLOWTITE Guide for Buried Pipes". The second parameter for pipe stiffness class selection is negative pressure, if it exists. **Table 9-4** shows which stiffness to select for various amounts of negative pressure and burial.

The following information is a partial review of installation procedures; it is not intended to replace the installation instructions which must be followed for any project. For more details please request our FLOWTITE underground / aboveground installation manual. Our subsidiaries are also always at your service.

Soil group	Granular		Cohesive		Modulus
	Blow count ¹	Description	q_u kPa	Description	M_{sn}
1	> 15	Compact	> 200	Very stiff	34.50
2	8 - 15	Slightly compact	100 - 200	Stiff	20.70
3	4 - 8	Loose	50 - 100	Medium	10.30
4	2 - 4		25 - 50	Soft	4.80
5	1 - 2	Very loose	13 - 25	Very soft	1.40
6	0 - 1	Very very loose	0 - 13	Very very soft	0.34

¹ Standard penetration test per ASTM D1586

Table 9-2 Native Soil Stiffness Groups. Values of Constrained Modulus, M_{sn}

Backfill Soil Stiffness Category	Description of Backfill Soils
SC1	Crushed rock with < 15% sand, maximum 25% passing the 9.5 mm sieve and maximum 5% fines ² .
SC2	Clean, coarse-grained soils: SW, SP1), GW, GP or any soil beginning with one of these symbols with 12% or less fines ² .
SC3	Clean, coarse-grained soils with fines: GM, GC, SM, SC or any soil beginning with one of these symbols with 12% or more fines ² . Sandy or gravely fine-grained soils: CL, ML, (or CL-ML, CL/ML, ML/CL) with 30% or more retained on a no. 200 sieve
SC4	Fine grained soils: CL, ML, (or CL-ML, CL/ML, ML/CL) with 30% or less retained on a no. 200 sieve

Note: Symbols in table are according to the Unified Soil Classification Designation, ASTM D2487
¹ Uniform fine sand, SP, with more than 50% passing no. 100 sieve (0.15 mm) is very sensitive to moisture and is not recommended as backfill.
² % fines is the weight percentage of soil particles that pass no. 200 sieve with 0.076 mm opening

Table 9-3 Backfill Soil Type Classification

DN mm	SN 2500			SN 5000			SN 10000		
	3 m	6 m	12 m	3 m	6 m	12 m	3 m	6 m	12 m
100	-	-	-	-	-	-	1.00	1.00	-
150	-	-	-	-	-	-	1.00	1.00	-
200	-	-	-	-	-	-	1.00	1.00	-
250	-	-	-	-	-	-	1.00	1.00	-
300	0.28	0.25	0.25	0.53	0.50	0.50	1.00	1.00	1.00
350	0.30	0.25	0.25	0.55	0.50	0.50	1.00	1.00	1.00
400	0.32	0.25	0.25	0.58	0.50	0.50	1.00	1.00	1.00
450	0.32	0.26	0.25	0.61	0.51	0.50	1.00	1.00	1.00
500	0.39	0.26	0.25	0.66	0.51	0.50	1.00	1.00	1.00
600	0.48	0.27	0.25	0.78	0.52	0.50	1.00	1.00	1.00
700	0.66	0.28	0.25	1.00	0.54	0.50	1.00	1.00	1.00
800	0.74	0.30	0.25	1.00	0.56	0.50	1.00	1.00	1.00
900	0.77	0.32	0.25	1.00	0.59	0.50	1.00	1.00	1.00
1000	0.82	0.36	0.26	1.00	0.64	0.51	1.00	1.00	1.00
1100	0.88	0.39	0.26	1.00	0.66	0.51	1.00	1.00	1.00
1200	0.95	0.46	0.26	1.00	0.77	0.52	1.00	1.00	1.00
1300	0.97	0.53	0.27	1.00	0.85	0.52	1.00	1.00	1.00
1400	1.00	0.62	0.28	1.00	0.98	0.53	1.00	1.00	1.00
1600	1.00	0.73	0.29	1.00	1.00	0.56	1.00	1.00	1.00
1800	1.00	0.77	0.32	1.00	1.00	0.59	1.00	1.00	1.00
2000	1.00	0.81	0.35	1.00	1.00	0.63	1.00	1.00	1.00
2200	1.00	0.87	0.40	1.00	1.00	0.69	1.00	1.00	1.00
2400	1.00	0.94	0.45	1.00	1.00	0.76	1.00	1.00	1.00
2600	1.00	1.00	0.50	1.00	1.00	0.84	1.00	1.00	1.00
2800	1.00	1.00	0.55	1.00	1.00	0.92	1.00	1.00	1.00
3000	1.00	1.00	0.60	1.00	1.00	1.00	1.00	1.00	1.00

**Table 9-4 Maximum Allowable Negative Pressure (bars) for Unburied Sections
 – Pipe Length between Restraints 3 m / 6 m / 12 m**

10 General Installation

Long life and the good performance characteristics of FLOWTITE pipe can only be achieved by proper handling and installation of the pipe. It is important for the owner, engineer and contractor to understand that glass-reinforced plastic (GRP) pipe is designed to utilise the bedding and pipe zone backfill support that will result from recommended installation procedures. Engineers have found through considerable experience that properly compacted granular materials are ideal for backfilling GRP pipe. Together, the pipe and embedment material form a high-performance “pipe-soil system.” For complete installation instructions, consult the FLOWTITE Instructions for Buried Pipe.

The following information is a partial review of installation procedures; it is not intended to replace the installation instructions which must be followed for any project

Installation design Parameters

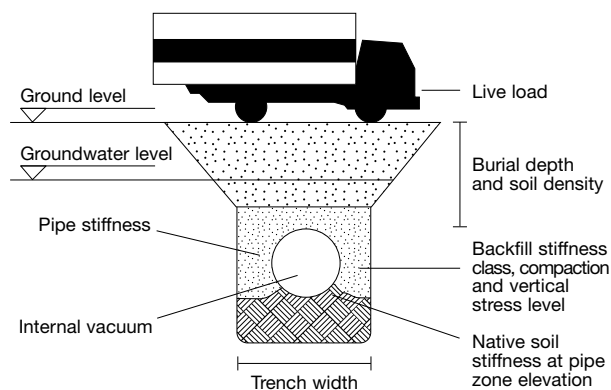

Figure 10-1 Installation Design Parameters

Bedding

The trench bed, of suitable material, should provide uniform and continuous support for the pipe.

Checking the Installed Pipe

After installation of each pipe, the maximum diametrical vertical deflection must be checked. With FLOWTITE pipe this procedure is fast and easy.

Installed Diametrical Deflection

The maximum allowable initial diametrical deflection (typically vertical) must be as follows:
Maximum Initial Deflection

> DN 300	≤ DN 250
3 %	2.5 %

Table 10-1 Stiffness Class

The maximum allowable long term diametrical deflection is 5% for diameters 300 mm and larger, and 4% for smaller diameters. These values apply to all stiffness classes.

Bulges, flat areas or other abrupt changes of pipe wall curvature are not permitted. All point loads should be avoided. Pipe installed outside of these limitations may not perform as intended.

Refer to “FLOWTITE installation guide for buried pipes” and the “FLOWTITE aboveground installation manual” for details.

Manholes/Valve Chambers

The FLOWTITE standard finished manholes and valve chambers are preferably used for laying sewer and closed pressure pipe systems as well as for the installation of fittings and armatures. AMIANTIT offers standard manholes as well as tangential manholes. Standard manholes have a fibreglass shaft connected to the manhole bottom and are manufactured in accordance with local regulations. Our manhole product range is well known for its light weight and high buoyancy safety.

The configuration, location and sizes of the inlet and outlet pipes along with the internal channel can be made to suit the site conditions. The pipe connections are leak proof and could be made to suit any sewer pipes used. Both the slopes and the angles of the drains and the inlet locations can be set as required to accommodate the project requirements.

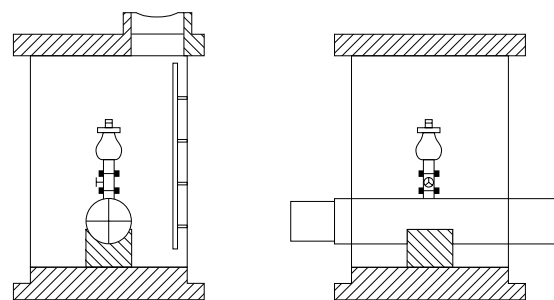

Figure 10-2 Valve Chambers

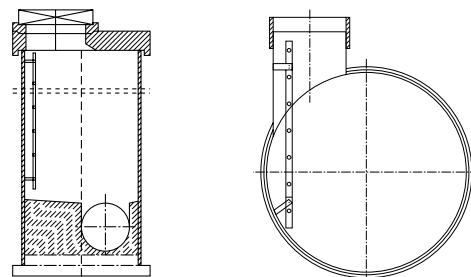

Figure 10-3 Standard and Tangential Manhole

Fittings

FLOWTITE Technology has created a standardised line of GRP fittings that are moulded or fabricated using the same materials that are used to produce FLOWTITE pipe. One of the benefits of FLOWTITE pipe is the ability to fabricate a wide assortment of fittings, both standard and non-standard.

Our FLOWTITE fittings can be supplied in the pressure classes listed below:

Pressure Class PN	Pressure Rating Bar	Upper diameter limit
1 (gravity)	1	3000
6	6	3000
10	10	3000
16	16	3000
20	20	3000
25	25	2400
32	32	1800

Table 10-2 Product Range

Thrust Block Requirements

The fitting information contained in this manual is directed towards standard buried FLOWTITE pipes. The fittings constructions are based on the fittings being installed according to FLOWTITE Pipe Handling and Buried Installation instructions. These instructions are predicated on axial forces being resisted by thrust restraints. The following is a summary of guidelines. The FLOWTITE Installation Instructions should be consulted for full details.

Thrust Restraints

When the pipeline is pressurised, unbalanced thrust forces occur at bends, reducers, tees, wyes, bulk heads and other changes in line direction. These forces must be restrained in some manner to prevent joint separation. When the surrounding soil cannot provide this restraint, thrust or stress/thrust blocks must be used. Determination of need and design of these restraints is the responsibility of the owner's engineer subject to the following limitations.

Thrust Blocks

Thrust blocks must limit the displacement of the fitting relative to the adjacent pipe to preserve the leak tightness of the FLOWTITE coupling joint. The resulting angular deflection shall be less than the values indicated.

The block must completely surround the fitting for its entire length and circumference and should be placed either against undisturbed earth or backfilled with pipe zone materials as appropriate for the native soil characteristics.

These blocks are applicable to:

- 1 All bends, reducers, bulkheads and blind flanges.
- 2 Tees*, when the branch pipe is concentric to the header pipe centreline.
- ! **Note***: It is not necessary to encase nozzle connections in concrete.

Nozzles are tee branches meeting all the following criteria:

- 1 Nozzle diameter < 300 mm.
- 2 Header diameter > 3 times nozzle diameter
- 3 If the nozzle is not concentric and/or not perpendicular to the header pipe axis, the nozzle diameter is considered to be the longest chord distance on the header pipe wall at the nozzle/pipe intersection

The block must completely surround the fitting for its entire length and circumference and should be placed either against undisturbed earth or backfilled with pipe zone material as appropriate for the native soil characteristics. These blocks are required for the following fittings when the line pressure exceeds 100 kPa (1 bar):

- 1 Bifurcations.
- 2 Custom fittings as noted by special instructions.

General instructions

Standard FLOWTITE pipes and fittings are joined by double bell couplings that can only resist limited axial thrust:

One of the most common methods of providing resistance to thrust forces is the use of thrust blocks. Resistance is provided by transferring the thrust force to the soil through the larger bearing area of the block, such that the resultant pressure against the soil does not exceed the horizontal bearing strength of the soil. Design of thrust blocks consists of determining the appropriate bearing area of the block for a particular set of conditions. The parameters involved in the design include pipe size, design pressure, angle of the bend (or configuration of the fitting involved), and the horizontal bearing strength of the soil. The following are the general criteria for bearing block design.

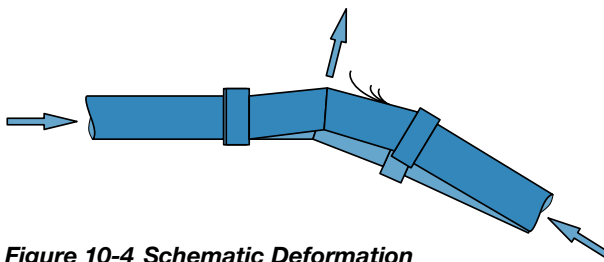

Figure 10-4 Schematic Deformation of Fittings due to Thrust Forces

In order to prevent joint separation or leakage, the thrust forces are usually resisted by concrete thrust blocks that transfer the load to the surrounding soil:

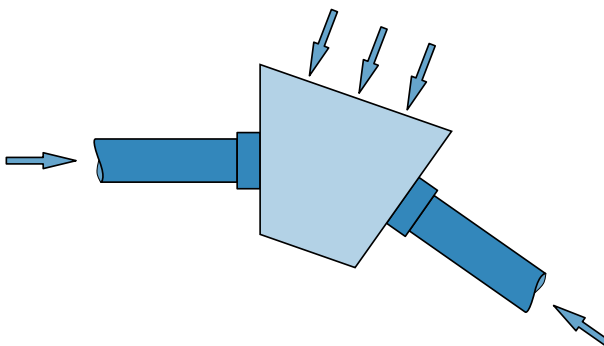

Figure 10-5 Schematic View of Concrete Reaction

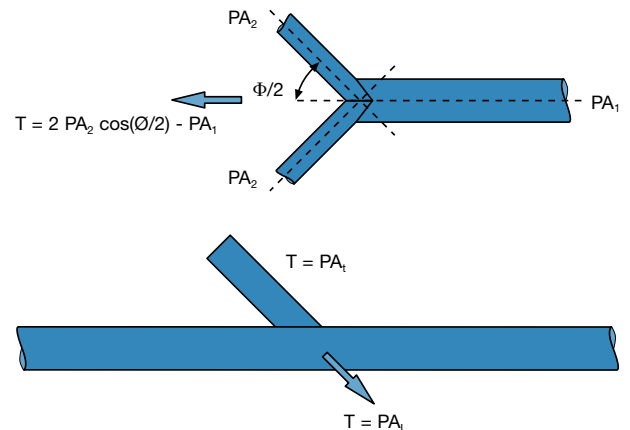
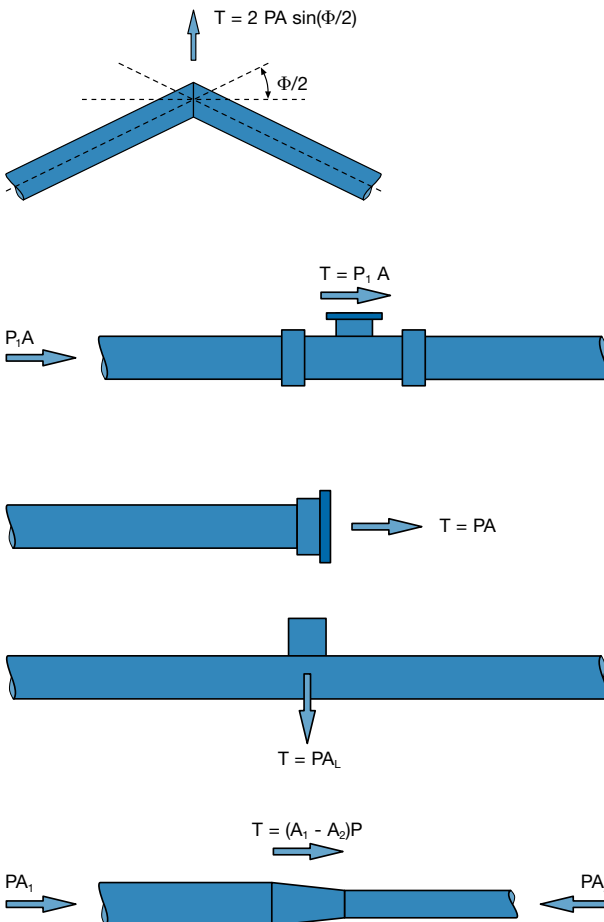

Figure 10-6 Thrust Forces

FLOWTITE fabricated fittings design is based on the following:

- The fitting shall be fully encased in concrete along its entire length and circumference. Our fittings are not designed for partial encasement.
- The movement of the thrust block must be limited so that the maximum deformation of the adjacent joints can take
- Buried thrust blocks transmit thrust to the soil by direct bearing.
- Partial resistance is also supplied by soil friction.
- Bearing surface should, where possible, be placed against undisturbed soil. Where it is not possible, the fill between the bearing surface and undisturbed soil must be compacted to at least 90% standard Proctor density.
- The bearing size of the thrust block depends on thrust force and soil strength:
 - $A_T = h \times b = T \times SF/\sigma$
 - Where h is block height, b is block width, T is thrust force, SF is safety factor ($=1.5$) and σ is the soil bearing strength.
- Thrust force should be based on test pressure of the pipeline, usually $1.5 \times PN$

The bearing surface should be placed against undisturbed soil perpendicular to, and centred on, the direction of the line of action of the thrust.

A thrustblock calculation software is available on www.flowtite.com

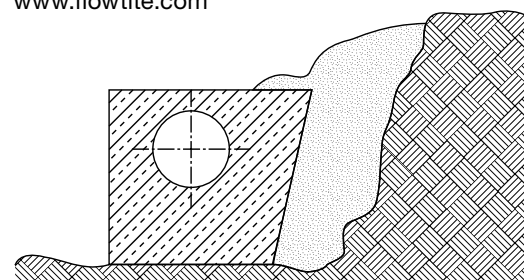

Figure 10-7 Interference Point between Thrust Block and Undisturbed Soil

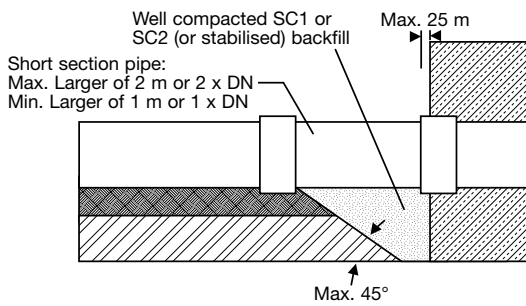

Figure 10-8 Position of Joints at Thrust Blocks

Burial depth to top of thrust block should be at least equal to its height to avoid shear failure of the soil. The width of the thrust block should be 1 to 2 x the height, to ensure even distribution of load. Where possible, the coupling joint shall be cast in concrete at the interface. If this is not possible rubber pads must be placed around the pipe where it enters the concrete encasement. Good compaction under the pipe to avoid differential settlement and crack-resisting steel reinforcement. Pipeline should not be pressure tested until concrete has cured at least 7 days.

The following table shows the thrust calculated with 1 bar and tested to 1.5 * pressure. For more details please request our FLOWTITE underground / aboveground installation manual. Our subsidiaries are also always at your service.

Soil Strength

Horizontal bearing strength of soil is very variable, and depends on the cohesion and the friction angle of the soil. This can be determined by the practice of soil mechanics.

The table is an estimate of bearing strength of several soils. The design engineer must select the proper bearing strength for a particular soil. For more details please request our FLOWTITE underground / aboveground installation manual. Our subsidiaries are also always at your service.

Soil	Bearing strength σ kN/m ²
Muck	0
Soft Clay	50
Silt	75
Sandy Silt	150
Sand	200
Sandy Clay	300
Hard Clay	450

Table 10-4 Bearing Strength Values

DN mm	Thrust due to 1 bar only (calculations are done based on test pressure of 1.5* PN)						
	90	60	45	30	22.5	15	Tee with branch = ND
100	1.67	1.18	0.90	0.61	0.46	0.31	1.18
150	3.75	2.65	2.03	1.37	1.03	0.69	2.65
200	6.66	4.71	3.61	2.44	1.84	1.23	4.71
300	14.99	10.60	8.12	5.49	4.14	2.77	10.60
350	20.41	14.43	11.05	7.47	5.63	3.77	14.43
400	26.66	18.85	14.43	9.76	7.35	4.92	18.85
450	33.74	23.86	18.26	12.35	9.31	6.23	23.86
500	41.65	29.45	22.54	15.24	11.49	7.69	29.45
600	59.98	42.41	32.46	21.95	16.55	11.07	42.41
700	81.64	57.73	44.18	29.88	22.52	15.07	57.73
800	106.63	75.40	57.71	39.03	29.42	19.68	75.40
900	134.95	95.43	73.04	49.40	37.23	24.91	95.43
1000	166.61	117.81	90.17	60.98	45.97	30.75	117.81
1200	239.92	169.65	129.84	87.82	66.19	44.29	169.65
1400	326.55	230.91	176.73	119.53	90.10	60.28	230.91
1600	426.52	301.59	230.83	156.12	117.68	78.73	301.59
1800	539.81	381.70	292.14	197.58	148.93	99.64	381.70
2000	666.43	471.24	360.67	243.93	183.87	123.02	471.24
2200	806.38	570.20	436.41	295.16	222.48	148.85	570.20
2400	959.66	678.58	519.37	351.26	264.77	177.15	678.58
2600	1126.27	796.39	609.53	412.24	310.74	207.90	796.39
2800	1306.21	923.63	706.91	478.11	360.38	241.12	923.63
3000	1499.47	1060.29	811.51	548.85	413.70	276.79	1060.29

Table 10-3 Thrust at 1 Bar Pressure

Design Example:

DN 600 PN 10 and a 30° bend in sandy clay.

The thrust force is: $T = 2 \cdot 1.5 \cdot 1 \cdot 280000 \sin(30/2)$
 $= 217 \text{ kN}$

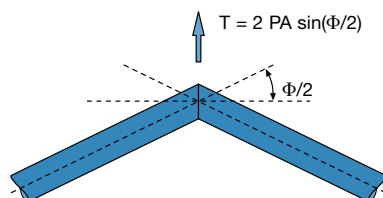

Figure 10-9 Thrust Force

The bearing strength is $\sigma = 300 \text{ kN/m}^2$.

$A_T = hxb = T FS/\sigma = 217 \cdot 1.5/300 = 1.1 \text{ m}^2$.

The coefficient of sub-grade reaction for sandy clay may be assumed to be 70 kN/m^2 .

The movement can thus be computed:

$D = 217/(1.1 \cdot 70) = 3 \text{ mm}$

Special Installation and Systems**Biaxial Pipe System****Joining Biaxial Systems**

Using biaxial systems with restrained joints there is no more need for thrust blocks. This will result in a more cost effective and a more simple solution from the installation point of view. The system joins the high sealing performance of the joint with a locking key system to transfer the axial thrust to adjacent pipes.

Glass fibre pipes manufactured according to this „FLOWTITE Technology Manufacturing and Process Specification” are flexible composite conduits made from glass fibre reinforcements, selected fillers and a thermosetting, chemical resistant polyester resin.

The FLOWTITE biaxial pipe system is designed to withstand full axial thrust in addition to the hoop load. The required axial strength is obtained through appropriate chop fibre capacity. The axial load is transferred from one pipe section to another through thrust restraint (biaxial) joints - rod groove system or butt-wrap laminates. For the locking joint, extra thickness is added to the pipe spigot to accommodate the locking groove. Outside the spigot area, and for butt-wrap joints, the pipe has a standard outer diameter (suitable for standard couplings). The extra thickness is created either by a hand laminate or directly on the FLOWTITE winder.

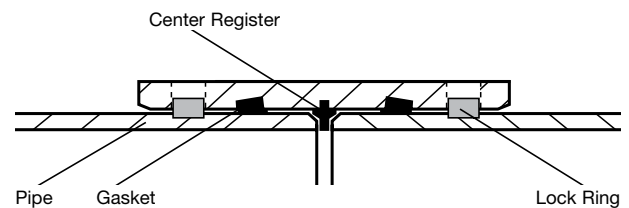

The pipes are produced on FLOWTITE TECHNOLOGY continuous CW3000 Filament Winding Equipment with controlled metering of materials to ensure uniform pipe properties from section to section.

Application

The pipes are designed for conveying water under pressure or gravity flow in buried applications.

Examples:

- Storm water
- Potable water
- Raw water
- Irrigation
- Seawater transmission
- Fire protection
- Cooling water
- Penstocks etc.

Combined Systems

Unbalanced thrust forces at fittings and changes of direction can be resisted using the restraint joints mentioned earlier. The pipes are tied together to increase the frictional drag of the joined pipes and resist the fitting thrust. This thrust will gradually decrease to a zero value at a distance L called the restrained length. Beyond this restrained length L the pipe will not see any thrust and therefore a standard joint can be used.

AWWA M-45 chapter 7 gives the equations to calculate the restrained length.

For a horizontal bend

$$L_{\text{bend}} = \frac{PA \sin(\Delta/2)}{f(2W_s + W_p + W_u)}$$

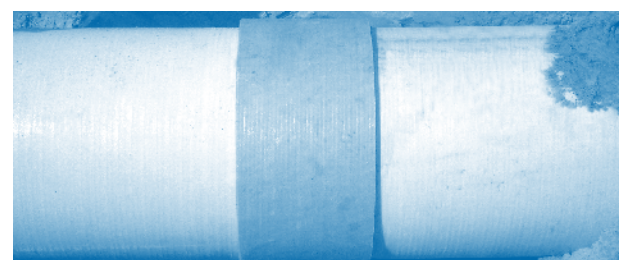

where: f = frictional resistance N/m
 W_e = weight of earth cover N/m
 W_p = weight of pipe N/m
 W_w = weight of fluid in the pipe N/m

For a bulk head or a Tee

$$L_{\text{bulk}} = \frac{PA}{f(2W_e + W_p + W_w)}$$

L is the restraint length on each side of the fittings.

Trenchless Installation

Today's growing urban areas may make it impractical to make open trench excavations and disrupt the surface conditions in order to install, replace or renovate underground piping systems. "Trenchless technology" includes the lining of existing pipes, called "slip-lining," where a new pipe is installed inside the existing deteriorating pipe. It can also include the micro-tunneling process of boring a hole and pushing or "jacking" the new pipe into the created excavation. FLOWTITE Technology has products/technology to meet these new application needs.

Slip-lining Capability

The FLOWTITE manufacturing process is unique in that it easily permits a custom product to be made to meet the specific project requirements. With the ability to make custom diameters, FLOWTITE can create the optimum pipe size to match the inside diameter of the existing pipeline. This will provide maximum flow capabilities while still permitting ease of installation.

Standard FLOWTITE pipe can be assembled outside the deteriorated pipe and then pushed into place. This can be done even with low flows (less than 1/3 full).

For pushing long distances, thrust rings can be built onto the spigot ends of the pipe, allowing the transfer of up to 40 tons per meter of circumference through the joint without affecting the sealing capability. This is especially important for rehabilitating renovating pressure lines. For very large diameters (over 1600 mm) the pipe can easily be carried using a light weight frame cart and assembled at it's final position.

The ability to manufacture variable lengths (standard length 6, 12 or 18 meters) can further help reduce installation time. Reduced installation time means lower installation costs and less "down-time" for the pipeline that is being rehabilitated.

Features & Benefits

Custom diameter

- Minimizes the loss of interior dimension of the existing pipe and maximizes the flow capabilities

Custom lengths

- Easier, faster installation, less pipe line service down-time

Slip-lining with flush joints, which allows for a close match of the internal diameter of the existing pipe and the external spigot diameter of the slip-lining, is also available. Slip-lining with flush joints is available in SN 5000 and SN 10000 with diameters ranging from 600 to 1900 mm.

Micro-Tunneling/Jacking Capability

The FLOWTITE pipe designed for micro-tunneling and jacking is a GRP and concrete composite which takes advantage of the attributes of both materials. The GRP portion of the pipe provides a corrosion resistant pipe which is pressure rated while using the concrete outer layer of the composite to withstand the very high forces needed for "jacking" the pipe. Since FLOWTITE jacking pipe is pressure rated, it is now possible to install pressure water and sewage systems using trenchless technology.

Features & Benefits

Corrosion-resistant

- All the benefits of standard FLOWTITE pipe material

FLOWTITE coupling

- Pressure ratings same as standard FLOWTITE pipe technology

Concrete outer layer

- Permits pipe to be "jacked" in same manner as non GRP pipes

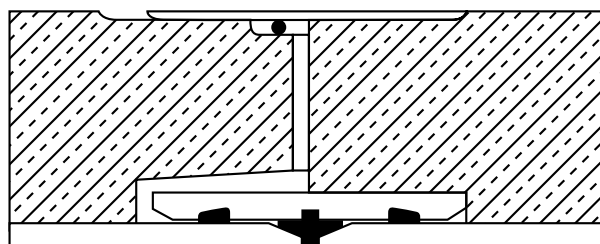

Figure 10-10 FLOWTITE Jacking System

Tapping Water Mains

Tapping is the process of connecting a branch to an existing pipeline. Care must be taken to ensure that a good seal is accomplished on the pipeline and that no damage is done to the pipe or tapping sleeve. Flexible stainless steel tapping sleeves have been proven to be the best suited for FLOWTITE GRP pipes. The tapped assembly must be able to resist a pressure of 2 x PN without leakage or damage to the pipe. It is essential that bolt torque is high enough to ensure no leakage, but not too high as to damage the pipe. It should be noted that the tapping sleeve manufacturer's recommended bolt torque values may be too high for GRP pipe. High stiffness, cast iron tapping sleeves have been found to cause too high stresses in a GRP pipe and their use should be avoided. Tapping machines can be either manual or power driven and must be able to resist the internal pressure in the pipe if a "hot" tap is to be performed. Forward feed should not exceed 0.5 mm per revolution in order to avoid damage to the pipe. The cutter can be either steel or diamond coated and should have small, closely spaced teeth. Please consult the FLOWTITE pipe suppliers for detailed instructions and recommended brands of tapping sleeves. For more details please request our FLOWTITE maintenance manual.

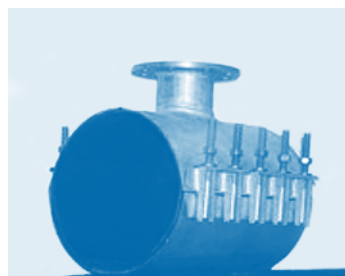

Figure 10-11 Recommended Tapping Sleeves for GRP Pipes

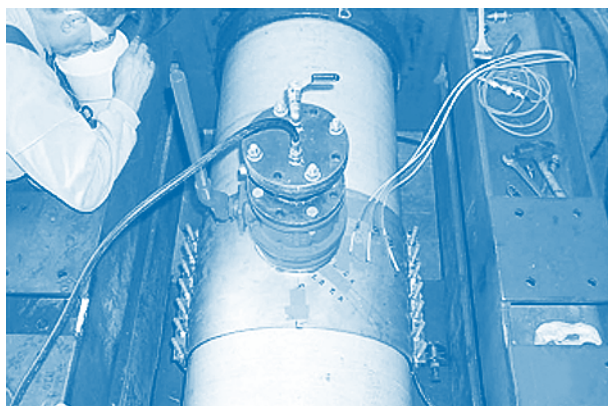

Figure 10-12 Pressure Testing of Sleeve and Valve Assembly

Sub-aqueous installation

GRP pipes are often installed under water especially for intake and outfall lines. It is often convenient that the pipes are joined together and towed to the position to be installed. The installation procedure may vary. FLOWTITE will provide specific installation instructions for any particular project.

The pictures below show some of the current installations.

More details are available in our FLOWTITE product brochure for subaqueous applications.



Aboveground installation

Standard FLOWTITE pipes can be installed above ground. The pipes can be either suspended or laid on supports. A complete installation manual is provided by FLOWTITE for the proper installation of above ground systems. For pipes used in this application, provision should be made to accommodate the unbalanced forces at fittings. Due to the low coefficient of linear expansion, the temperature difference, although much higher than in an underground system, is of no great concern. The effect is accommodated by the joint system and the type of supports. For more details please request our FLOWTITE aboveground installation manual.

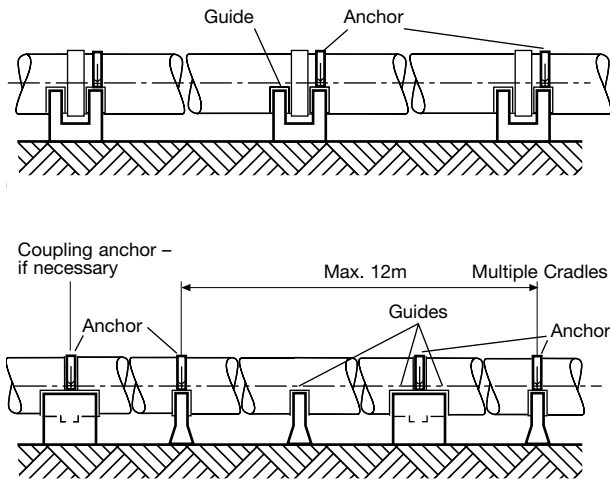

Figure 10-13 Typical support arrangement

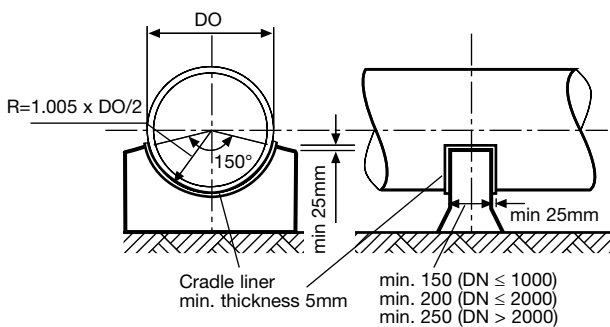

Figure 10-14 Cradle support design

AMITOOLS is an AMIANTIT online service offering software tools for static calculation of buried pipes and hydraulic calculation. The software tools, exclusively developed for AMIANTIT GRP pipe systems, offer the following main features:

- Free of charge.
- No software installation on your local PC necessary.
- In many different language versions available.
- Metric or imperial dimensions.
- Calculation of pipe systems in standard diameter range.
- Static calculation according to German (ATV), American (AWWA) and Fascicule70 standards.
- Laying conditions available as scaled sketch.
- Results are delivered as abbreviated version or as full report.
- Some calculation can be submitted online to your AMIANTIT sales office for quotation purposes.

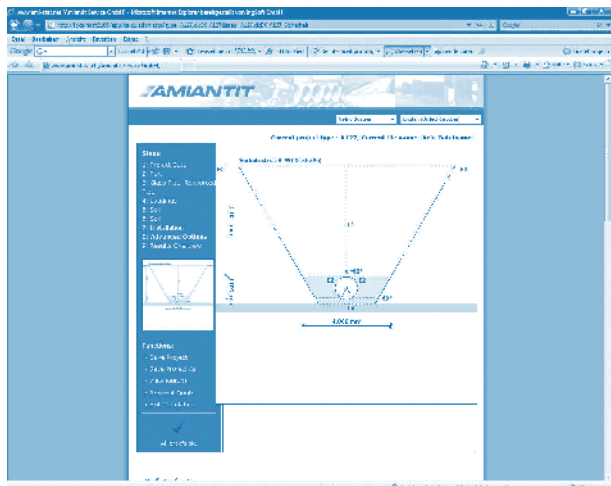

Figure 11-1 AMITOOLS Software

Register yourself immediately!
Apply for your personal licence at www.ami-tools.net!

12 Appendix A / Environmental Guide for Pipes

The following guide was compiled from corrosion resistance information obtained from resin manufacturers. Individual project specifications and requirements should be considered when selecting the product. At operation temperatures greater than 35° C pressure rating of the pipe may be required. Please contact your local FLOWTITE sales representative for further guidance.

Maximum Temperature 50° C unless otherwise noted. Please contact your FLOWTITE sales representative for recommendations above 50 °C. For chemicals not listed, FLOWTITE representative should be also consulted.

	Standard Pipe Resin or Vinyl Ester	Vinyl Ester Only	Not Recommended
Acetic Acid <20%**		●	
Adipic Acid**		●	
Alum (Aluminum Potassium Sulfate) (45°C)	●		
Aluminum Chloride, Aqueous (40°C)	●		
Ammonia, Aqueous <20%		●	
Ammonium Chloride, Aqueous (40°C)	●		
Ammonium Fluoride			●
Ammonium Nitrate, Aqueous (40°C)	●		
Ammonium Phosphate-Monobasic, Aqueous (40°C)	●		
Ammonium Sulfate, Aqueous (40°C)	●		
Aniline Hydrochloride		●	
Antimony Trichloride (40° C)**	●		
Barium Carbonate**		●	
Barium Chloride (40°C)	●		
Barium Sulfate (40°C)	●		
Beet Sugar Liquor		●	
Benzene Sulfonic Acid (10%)*		●	
Benzoic Acid*		●	
Black Liquor (Paper)		●	
Bleach			●
Borax (40°)	●		
Boric Acid		●	
Bromine, Aqueous 5%*		●	
Butyric Acid, < 25% (40°C)**		●	
Calcium Bisulfite*		●	
Calcium Carbonate		●	
Calcium Chlorate, Aqueous (40°C)**	●		
Calcium Chloride (Saturated) (40°C)	●		
Calcium Hydroxide, 100%		●	
Calcium Hypochlorite		●	
Calcium Nitrate (40°C)	●		
Calcium Sulfate NL AOC (40°C)	●		
Cane Sugar Liquors		●	
Carbon Dioxide, Aqueous (40°C)	●		
Carbon Tetrachloride			●
Casein	●		
Caustic Potash (KOH) (40°C)		●	
Chlorine, Dry Gas*		●	
Chlorine, Water*		●	
Chlorine, Wet Gas**		●	
Chloroacetic Acid			●

	Standard Pipe Resin or Vinyl Ester	Vinyl Ester Only	Not Recommended
Citric Acid, Aqueous		●	
Copper Acetate, Aqueous (40°C)	●		
Copper Chloride, Aqueous (40°C)	●		
Copper Cyanide (30°C)		●	
Copper Nitrate, Aqueous (40°C)	●		
Copper Sulfate, Aqueous (40°C)	●		
Crude Oil (Sour) (30°C)*	●		
Crude Oil (Sweet) (30°C)*	●		
Crude Oil, Salt Water (25°C)*		●	
Cyclohexane (40°C)*		●	
Cyclohexanol (30°C)*		●	
Dibutyl Sebacate (25°C)	●		
Dibutylphthalate (25°)	●		
Diesel Fuel (25°)*	●		
Diocetyl Phthalate (40°C)**	●		
Ethylene Glycol (40°C)	●		
Ferric Chloride, Aqueous (40°C)	●		
Ferric Nitrate, Aqueous (30°C)	●		
Ferric Sulfate, Aqueous (40°C)	●		
Ferrous Chloride (30°C)	●		
Ferrous Nitrate, Aqueous (30°C)**	●		
Ferrous Sulfate, Aqueous (40°C)	●		
Formaldehyde			●
Fuel Oil (25°C)*	●		
Gas, Natural, Methane			●
Gasoline, Ethyl*		●	
Glycerine		●	
Green Liquor, Paper		●	
Hexane (30°C)*	●		
Hydrobromic Acid			●
Hydrochloric Acid, Up To 15% (25°C)	●		
Hydrofluoric Acid			●
Hydrogen Sulfide, Dry		●	
Kerosene*		●	
Lactic Acid, 10% (30°C)	●		
Lactic Acid, 80% (25°C)	●		
Lauric Acid (40°C)	●		
Lauryl Chloride**	●		
Lauryl Sulfate**	●		
Lead Acetate, Aqueous (25°C)	●		
Lead Nitrate, Aqueous (25°C)	●		
Lead Sulfate**	●		

Note: This guide is intended to serve as a basic guide when considering FLOWTITE pipe. Final determination of the suitability of a particular resin system for a given environment is the responsibility of the customer. This list is based on information supplied by resin manufacturers who provide FLOWTITE producers with their

material. Thus, this guide provides only general information and does not imply approval of any application as FLOWTITE Technology has no control of the conditions of usage nor any means of identifying environments to which the pipe may unintentionally have been exposed.

	Standard Pipe Resin or Vinyl Ester	Vinyl Ester Only	Not Recommended
Linseed Oil*	●		
Lithium Bromide, Aqueous (40°C)**	●		
Lithium Chloride, Aqueous (40°C)**	●		
Magnesium Bicarbonate, Aqueous (30°C)**	●		
Magnesium Carbonate (40°C)**		●	
Magnesium Chloride, Aqueous (40°C)	●		
Magnesium Nitrate, Aqueous (40°C)	●		
Magnesium Sulfate (40°C)	●		
Manganese Chloride, Aqueous (40°C)**	●		
Manganese Sulfate, Aqueous (40°C)**	●		
Mercuric Chloride, Aqueous (40°C)	●		
Mercurous Chloride, Aqueous (40°C)**	●		
Mineral Oils*	●		
n-Heptane (25°C)*	●		
Naphthalene (30°C)*	●		
Naptha*		●	
Nickel Chloride, Aqueous (40°C)	●		
Nickel Nitrate, Aqueous (40°C)	●		
Nickel Sulfate, Aqueous (40°C)	●		
Nitric Acid			●
Oleic Acid (40°C)	●		
Oxalic Acid, Aqueous		●	
Ozone, Gas			●
Paraffin (30°C)*	●		
Pentane (30°C)*	●		
Perchloric Acid (25°C)		●	
Petroleum, Refined & Sour*		●	
Phosphoric Acid		●	
Phosphoric Acid (30°C)	●		
Phthalic Acid (30°C)		●	
Potassium Permanganate, 25%**		●	
Potassium Bicarbonate**		●	
Potassium Bromide, Aqueous (40°C)**	●		
Potassium Chloride, Aqueous (40°C)	●		
Potassium Dichromate, Aqueous (40°C)	●		
Potassium Ferrocyanide (40°C)**	●		
Potassium Ferrocyanide, Aqueous (40°C)**	●		
Potassium Nitrate, Aqueous (40°C)	●		
Potassium Sulfate (40°C)	●		

	Standard Pipe Resin or Vinyl Ester	Vinyl Ester Only	Not Recommended
Propylene Glycol (30°C)	●		
Sea Water (40°C)	●		
Sewage (50°C)	●		
Silicone Oil (40°C)	●		
Silver Nitrate, Aqueous (40°C)	●		
Sodium Bromide, Aqueous (40°C)**	●		
Sodium Chloride, Aqueous (40°C)	●		
Sodium Dichromate (25°C)	●		
Sodium Dihydrogen Phosphate (40°C)	●		
Sodium Ferrocyanide (40°C)**	●		
Sodium Hydroxide 10%		●	
Sodium Mono-Phosphate		●	
Sodium Nitrate, Aqueous (40°C)	●		
Sodium Nitrite, Aqueous (40°C)**	●		
Sodium Silicate		●	
Sodium Sulfate, Aqueous (40°C)	●		
Sodium Sulfide		●	
Sodium Tetraborate (30°C)**	●		
Stannic Chloride, Aqueous (40°C)*	●		
Stannous Chloride, Aqueous (40°C)	●		
Stearic Acid (40°C)**	●		
Sulfur			●
Sulfuric Acid, <25%(25°C)*	●		
Tannic Acid, Aqueous (35°C)	●		
Tartaric Acid (30°C)	●		
Toluene Sulfonic Acid**		●	
Tributyl Phosphate (40°C)		●	
Triethanolamine (40°C)		●	
Triethylamine (40°C)*		●	
Turpentine*		●	
Urea, Aqueous (30°C)**	●		
Vinegar (25°C)	●		
Water, Distilled (40°C)	●		
Water, Sea (40°C)	●		
Water, Tap (40°C)	●		
Zinc Chloride, Aqueous (40°C)	●		
Zinc Nitrate, Aqueous (40°C)**	●		
Zinc Sulfate, Aqueous (40°C)	●		
Zinc Sulfite, Aqueous (40°C)**	●		

* EPDM gaskets cannot be used. Please consult your FLOWTITE sales representative for more information and recommendations.
** No FLOWTITE Technology recommendation, consult your local gasket supplier for compatibility.

01

02

03

04

05

06

07

08

09

10

11

12

01

02

03

04

05

06

07

08

09

10

11

12

This handbook is intended as a guide only. All values listed in the product specifications are nominal. Unsatisfactory product results may occur due to environmental fluctuations, variations in operating procedures, or interpolation of data. We highly recommend that any personnel using this data have specialised training and experience in the application of these products and their normal installation and operating conditions. The engineering staff should always be consulted before any of these products are installed to ensure the suitability of the products for their intended purpose and applications. We hereby state that we do not accept any liability, and will not be held liable, for any losses or damage which may result from the installation or use of any products listed in this handbook as we have not determined the degree of care required for product installation or service. We reserve the right to revise this data, as necessary, without notice. We welcome comments regarding this handbook.

The Flowtite technology is owned and licensed worldwide by Amiblu. Find more information and contact details at www.amiblu.com.



Amiblu Technology AS

Østre Kullerød 3
3202 Sandefjord
Norway
T: + 47 971 00 300
info.technology@amiblu.com
www.amiblu.com

Distributed by: ■